

On Board Diagnostics II

Subject	Page
Overview of On-Board Diagnostics (OBD I & II)	2
Overview of the National Low Emission Vehicle Program.	3
Emission Compliance	4
OBD Function: Driving Cycle	5
Federal Test Procedure (FTP)	6
OBD Function: “Check Engine” (MIL) Light	8
OBD Diagnostic Trouble Code (DTC)	10
Scan Tool Connection	11
BMW Fault Code (DIS/MoDiC)	12
BMW Diagnosis	13
OBD Glossary	35

OVERVIEW OF ON-BOARD DIAGNOSTICS (OBD I & III)

- In continuing efforts to improve air quality, the Environmental Protection Agency (EPA) amended the Clean Air Act in 1990. The Clean Air Act was originally mandated in 1970. The Clean Air Act has a direct impact on automobile manufactures whereby they are responsible to comply with the regulations set forth by the EPA. The 1990 amendment of the Clean Air Act set forth all of the changes currently being introduced on vehicles sold in the United States today.
- In 1967, the State of California formed the California Air Resources Board (CARB) to develop and carryout air quality improvement programs for California's unique air pollution conditions. Through the years, CARB programs have evolved into what we now know as ON Board Diagnostics (OBD) and the National Low Emission Vehicle Program.
- The EPA has adopted many of the CARB programs as National programs and laws. One of these earlier programs was OBD I and the introduction of the "CHECK ENGINE" Light.
- BMW first introduced OBD I and the check engine light in the 1987 model year. This enhanced diagnosis through the display of "flash codes" using the check engine light as well as the BMW 2013 and MoDiC. OBD I was only the first step in an ongoing effort to monitor and reduce tailpipe emissions.
- By the 1989 model year all automotive manufactures had to assure that all individual components influencing the composition of exhaust emissions would be electrically monitored and that the driver be informed whenever such a component failed.
- Since the 1996 model year all vehicles must comply with OBD II requirements. OBD II requires the monitoring of virtually every component that can affect the emission performance of a vehicle plus store the associated fault code and condition in memory.

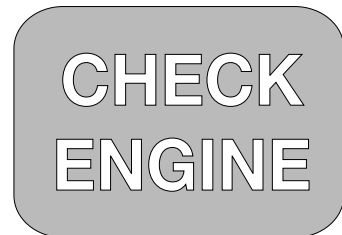

If a problem is detected and then re-detected during a later drive cycle more than one time, the OBD II system must also illuminate the Check Engine Light in the instrument cluster to alert the driver that a malfunction has occurred. However, the flash code function of the Check Engine Light in OBD I vehicles is not a function in OBD II vehicles.

- This requirement is carried out by the Engine Control Module (ECM/DME) as well as the Automatic Transmission Control Module (EGS/AGS) and the Electronic Throttle Control Module (EML) to monitor and store faults associated with all components/systems that can influence exhaust and evaporative emissions.

OVERVIEW OF THE NATIONAL LOW EMISSION VEHICLE PROGRAM

Emission Reduction Stages:

While OBD II has the function of monitoring for emission related faults and alerting the operator of the vehicle, the National Low Emission Vehicle Program requires a certain number of vehicles produced (specific to manufacturing totals) currently comply with the following emission stages;

TLEV: Transitional Low Emission Vehicle

LEV: Low Emission Vehicle

ULEV: Ultra Low Emission Vehicle.

Prior to the National Low Emission Vehicle Program, the most stringent exhaust reduction compliancy is what is known internally within BMW as HC II. The benefit of exhaust emission reductions that the National Low Emission Vehicle Program provides compared with the HC II standard is as follows:

Cold Engine Startup - 50° F TLEV- 50% cleaner.

Grams/Mile - "New" LEV- 70% cleaner.

Compliance Level	NMHC Non Methane Hydrocarbon	CO Carbon Monoxide	NOx Oxide(s) of Nitrogen
TLEV	0.250	3.4	0.4
LEV	0.131	3.4	0.2
ULEV	0.040	1.7	0.2

ULEV- 84% cleaner.

Grams/Mile at 50,000 miles

Compliance Level	NMHC Non Methane Hydrocarbon	CO Carbon Monoxide	NOx Oxide(s) of Nitrogen
TLEV	0.125	3.4	0.4
LEV	0.075	3.4	0.2
ULEV	0.040	1.7	0.2

Grams/Mile at 100,000 miles

Compliance Level	NMHC Non Methane Hydrocarbon	CO Carbon Monoxide	NOx Oxide(s) of Nitrogen
TLEV	0.156	4.2	0.6
LEV	0.090	4.2	0.3
ULEV	0.055	2.1	0.3

OBD II TAILPIPE EMISSION COMPLIANCE

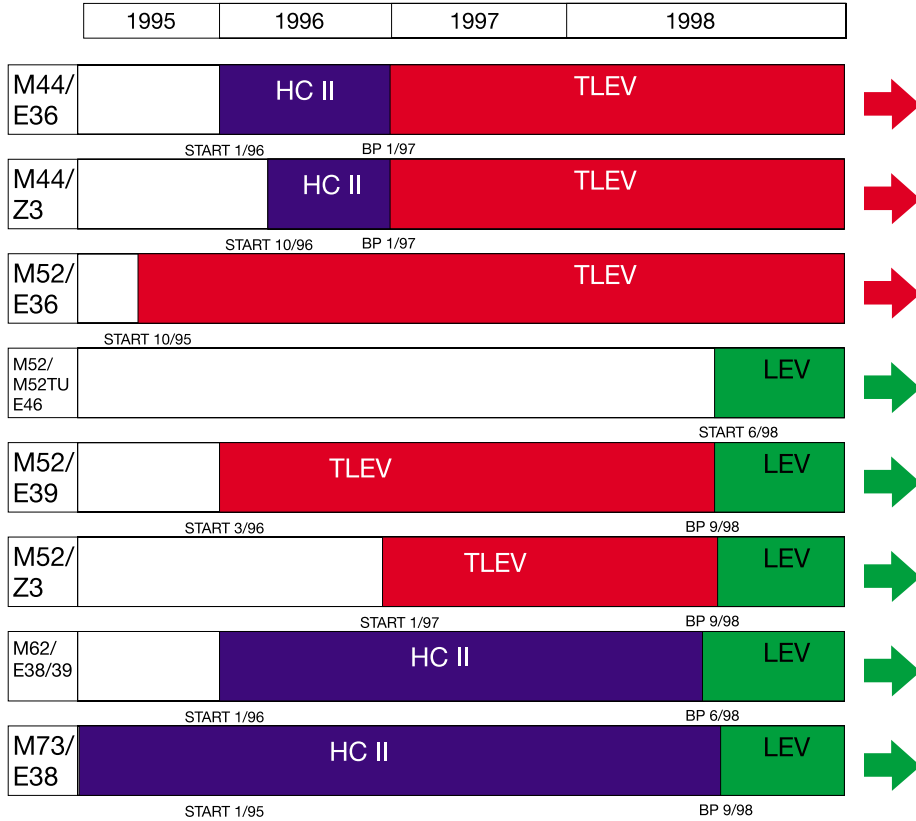

OBD II EVAPORATIVE EMISSION COMPLIANCE

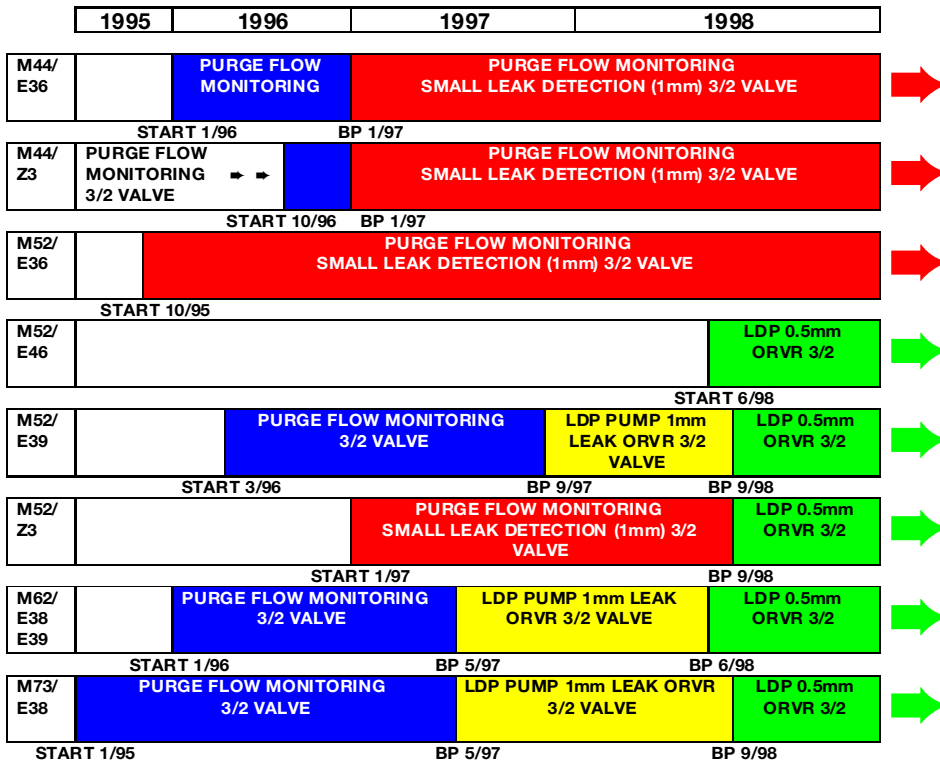

OBD-II FUNCTION: DRIVING CYCLE

As defined within CARB mail-out 1968.1:

“Trip” is defined as vehicle operation (following an engine-off period) of duration and driving style so that all components and systems are monitored at least once by the diagnostic system except catalyst efficiency or evaporative system monitoring. This definition is subject to the limitations that the manufacturer-defined trip monitoring conditions are all monitored at least once during the first engine start portion of the Federal Test Procedure (FTP).

Within this text the term **“customer driving cycle”** will be used and is defined as engine start-up, operation of vehicle (dependent upon customer drive style) and engine shut-off.

FEDERAL TEST PROCEDURE (FTP)

The Federal Test Procedure (FTP) is a **specific driving cycle** that is utilized by the EPA to test light duty vehicles and light duty truck emissions. As part of the procedure for a vehicle manufacturer to obtain emission certification for a particular model/engine family the manufacturer must demonstrate that the vehicle(s) can pass the FTP defined driving cycle **two consecutive times** while monitoring various components/systems.

Some of the components/systems must be monitored ***either once per driving cycle or continuously***.

1. Components/systems required to be monitored **once within one driving cycle**:

- Oxygen Sensors
- Secondary Air Injection System
- Catalyst Efficiency
- Evaporative Vapor Recovery System

NOTE: Due to the complexity involved in meeting the test criteria within the FTP defined driving cycle, all tests may not be completed within one "customer driving cycle". The test can be successfully completed within the FTP defined criteria, however customer driving styles may differ and therefore may not always monitor all involved components/systems in one "trip".

Components/systems required to be monitored ***continuously***:

- Misfire Detection
- Fuel system
- Oxygen Sensors
- All emissions related components/systems providing or getting electrical connections to the DME, EGS, or EML.

The graph shown below is an **example** of the driving cycle that is used by BMW to complete the FTP.

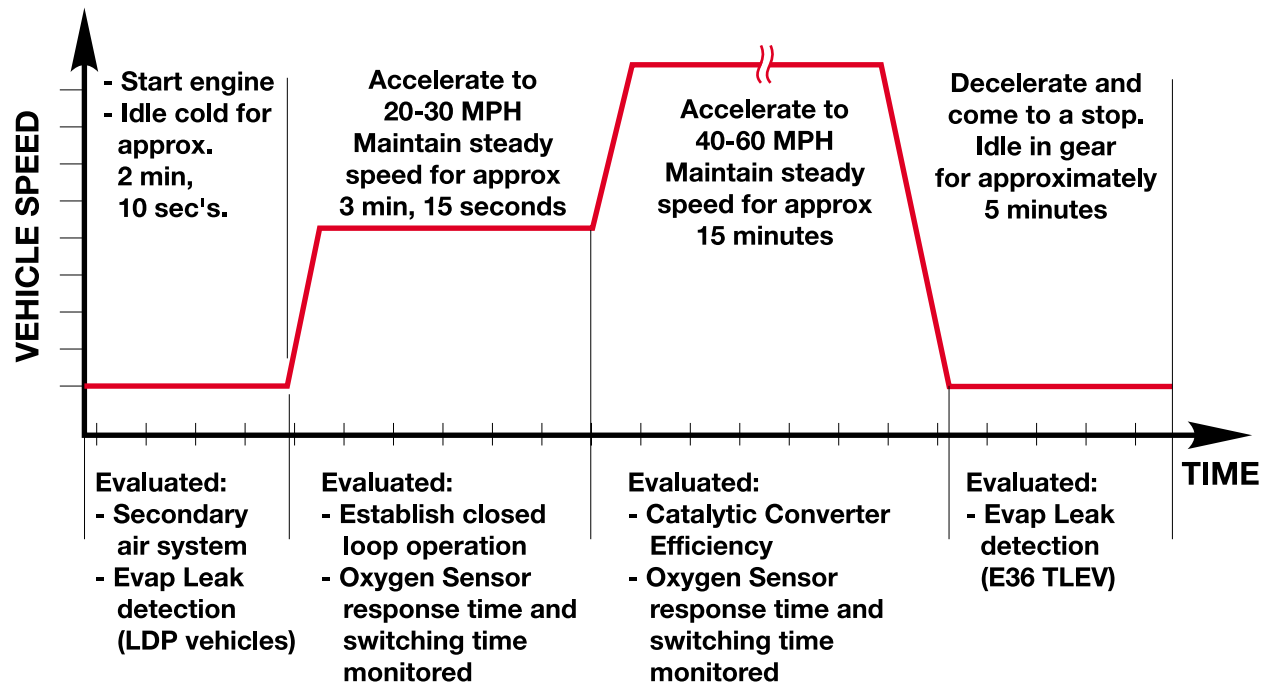

The diagnostic routine shown above will be discontinued whenever:

- Engine speed exceeds 3000 RPM
- Large fluctuations in throttle angle
- Road speed exceeds 60 MPH

NOTE: The driving criteria shown can be completed within the FTP required ~11 miles in a controlled environment such as a dyno test or test track.

A “customer driving cycle” may vary according to traffic patterns, route selection and distance traveled, which may not allow the “diagnostic trip” to be fully completed each time the vehicle is operated.

OBD II FUNCTION: "CHECK ENGINE" (MIL) LIGHT

In conjunction with the CARB/OBD II regulations "CHECK ENGINE" light (also referred to as the Malfunction Indicator Light - MIL) is to be illuminated under the following conditions:

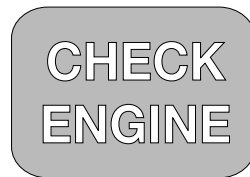







- Upon the completion of the second consecutive driving cycle where the previously faulted system is monitored again and the emissions relevant fault is again present.
- Immediately if a catalyst damaging fault occurs (see Misfire Detection).

The illumination of the check engine light is performed in accordance with the Federal Test Procedure (FTP) which requires the lamp to be illuminated when:

- A malfunction of a component that can affect the emission performance of the vehicle occurs and causes emissions to exceed 1.5 times the standards required by the (FTP).
- Manufacturer-defined specifications are exceeded.
- An implausible input signal is generated.
- Catalyst deterioration causes HC-emissions to exceed a limit equivalent to 1.5 times the standard (FTP).
- Misfire faults occur.
- A leak is detected in the evaporative system
- The oxygen sensors observe no purge flow from the purge valve/evaporative system.
- Engine control module fails to enter closed-loop operation within a specified time interval.
- Engine control or automatic transmission control enters a "limp home" operating mode.
- Key is in the "ignition" on position before cranking (Bulb Check Function).

Within the BMW system the illumination of the check engine light is performed in accordance with the regulations set forth in CARB mail-out 1968.1 and as demonstrated via the Federal Test Procedure (FTP).

The following information provides several examples of when and how the "Check Engine" Light is illuminated based on the "customer drive cycle" (DC):

TEXT NO.	TRIP # 1			TRIP # 2			TRIP # 3			TRIP # 4			TRIP # 5			* TRIP # 43		
	FUNCTION CHECKED	FAULT CODE SET	MIL STATUS 	FUNCTION CHECKED	FAULT CODE SET	MIL STATUS 	FUNCTION CHECKED	FAULT CODE SET	MIL STATUS 	FUNCTION CHECKED	FAULT CODE SET	MIL STATUS 	FUNCTION CHECKED	FAULT CODE SET	MIL STATUS 	FUNCTION CHECKED	FAULT CODE SET	MIL STATUS 
1.	YES	YES	OFF															
2.	YES	YES	OFF	YES	YES	ON												
3.	YES	YES	OFF	NO	NO	OFF	YES	YES	ON									
4.	YES	YES	OFF	YES	NO	OFF	YES	NO	OFF	YES	YES	OFF	YES	YES	ON			
5.	YES	YES	OFF	YES	YES	ON	YES	NO	ON	YES	NO	ON	YES	NO	OFF			
6.	YES	YES	OFF	YES	YES	ON	YES	NO	ON	YES	NO	ON	YES	NO	OFF	YES	NO	OFF
																YES	FAULT CODE ERASED	OFF

1. A fault code is stored within the respective control module upon the first occurrence of a fault in the system being checked.
2. The “Check Engine” (MIL) light will not be illuminated until the completion of the second consecutive “customer driving cycle” where the previously faulted system is again monitored and a fault is still present or a catalyst damaging fault has occurred.
3. If the second drive cycle was not complete and the specific function was not checked as shown in the example, the engine control module counts the third drive cycle as the “next consecutive” drive cycle. The check engine light is illuminated if the function is checked and the fault is still present.
4. If there is an intermittent fault present and does not cause a fault to be set through multiple drive cycles, two **complete** consecutive drive cycles with the fault present are required for the Check Engine light to be illuminated.
5. Once the “Check Engine” light is illuminated it will remain illuminated unless the specific function has been checked without fault through three complete consecutive drive cycles.
6. The fault code will also be cleared from memory automatically if the specific function is checked through 40* consecutive drive cycles without the fault being detected or with the use of either the DIS, MODIC or Scan tool.

* **NOTE:** In order to clear a catalyst damaging fault (see Misfire Detection) from memory, the condition under which the fault occurred must be evaluated for 80 consecutive cycles without the fault reoccurring.

With the use of a universal scan tool, connected to the “OBD” DLC an SAE standardized DTC can be obtained, along with the **condition associated** with the illumination of the “Check Engine” light.

Using the DIS or MODIC, a fault code and the conditions associated with its setting **can be obtained prior to the illumination of the “Check Engine” light.**

OBD II Diagnostic Trouble Codes (DTC)

The Society of Automotive Engineers (SAE) established the Diagnostic Trouble Codes used for OBD II systems (SAE J2012). The DTC's are designed to be identified by their alpha/numeric structure. The SAE has designated the emission related DTC's to start with the letter "P" for Powertrain related systems, hence their *nickname* "P-code".

For example:

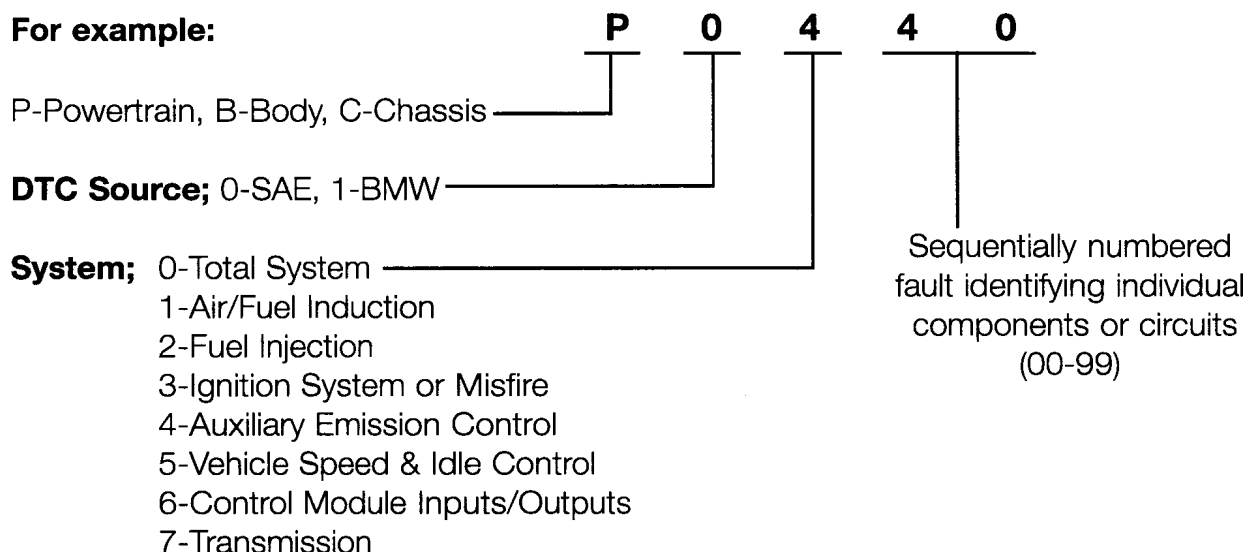

- DTC's are stored whenever the Check Engine Light (MIL) is illuminated.
- A requirement of CARB/EPA is providing universal diagnostic access to DTC's via a standardized Diagnostic Link Connector (DLC) using a standardized tester (scan tool).
- DTC's only provide one set of environmental operating conditions when a fault is stored. This single "Freeze Frame" or snapshot refers to a block of the vehicles environmental conditions for a specific time when the fault first occurred. The information which is stored is defined by SAE and is limited in scope. This information may not even be specific to the type of fault.

DTC Storage:

The table represents the stored information that would be available via an aftermarket scan tool if the same fault occurred 5 times

Bosch Systems	Aftermarket Scan Tool
initial fault	SAE defined freeze frame conditions
2nd occurrence	n/a
3rd occurrence	n/a
last occurrence	n/a
Siemens Systems	Aftermarket Scan Tool
initial fault	SAE defined freeze frame conditions

Scan Tool Connection:

Starting with the 1995 750 iL and soon after on all 1996 model year BMW vehicles, a separate OBD II Diagnostic Link Connector (DLC) was added.

The DLC provides access for an aftermarket scan tool to test emission related control systems (DME/AGS/EGS and EML). This diagnostic communication link uses the existing TXD II circuit in the vehicle through a separate circuit on the DLC when the 20 pin cap is installed.

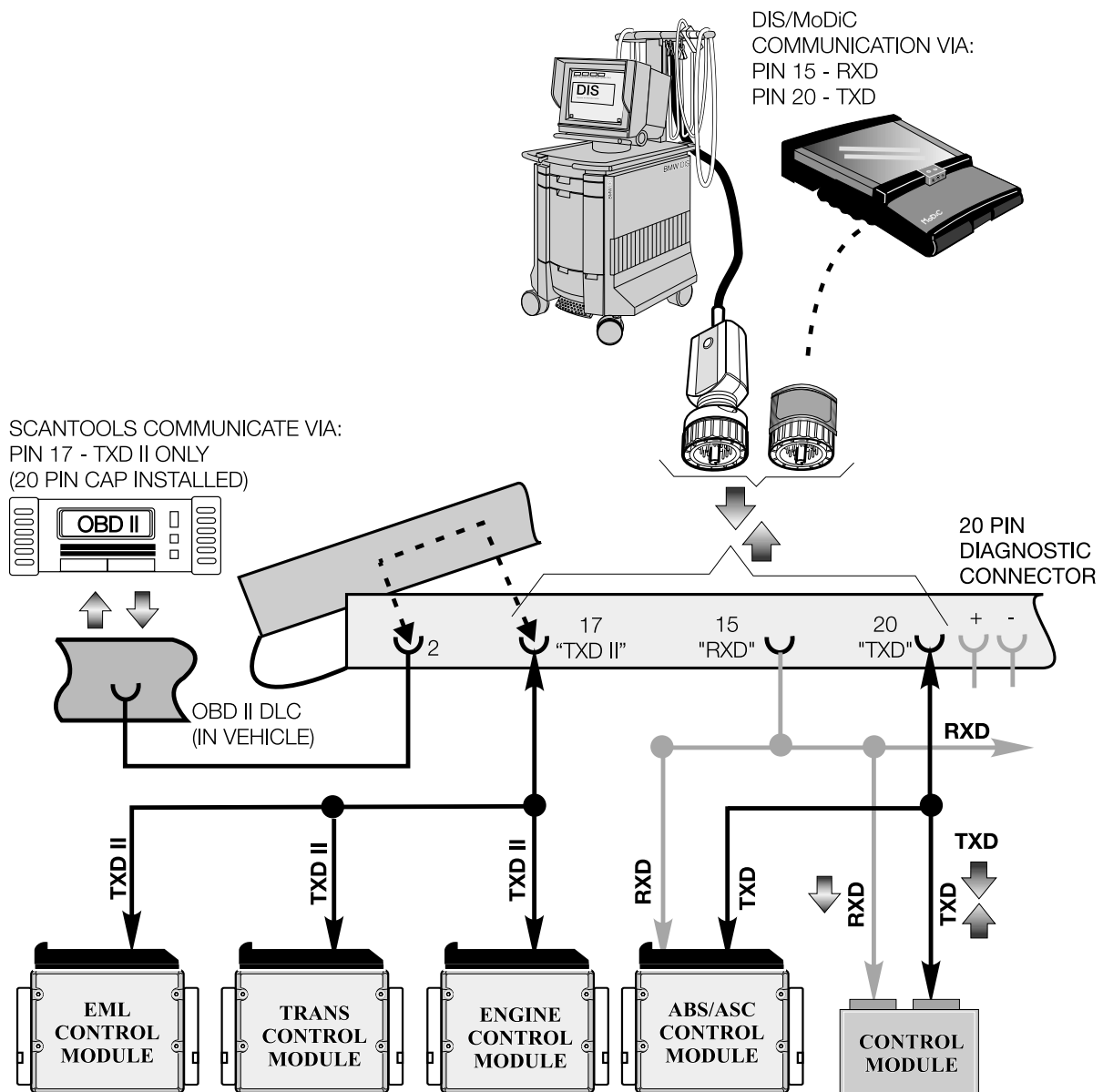

BMW Fault Code (DIS/MoDiC)

- BMW Codes are stored as soon as they occur even before the Check Engine Light (MIL) comes on.
- BMW Codes are defined by BMW, Bosch, and Siemens Engineers to provide greater detail to fault specific information.
- Siemens system - (1) SET OF (4) fault specific environmental conditions are stored with the first fault occurrence. This information can change and is specific to each fault code to aid in diagnosing. A maximum of (10) different faults containing (4) environmental conditions can be stored.
- Bosch systems- a maximum of (4) sets of (3) fault specific environmental conditions are stored within each fault code. This information can change and is specific to each fault code to aid in diagnosing. A maximum of (10) different faults containing (3) environmental conditions can be stored.
- BMW Codes also store and display a “time stamp” when the fault last occurred.
- A fault qualifier gives more specific detailed information about the type of fault (upper limit, lower limit, disconnection, plausibility, etc.).
- BMW Fault Codes will alert the technician of the current fault status. He will be advised if the fault is actually still present, not currently present or intermittent. The fault specific information is stored and accessible through DIS or MoDiC.
- BMW Fault Codes determine the diagnostic output for BMW DIS and MoDiC.

BMW Fault Code Storage:

The table below represents the information that would be available via the DIS tester if the same fault occurred 5 times.

Bosch Systems	DIS Tester Information
initial fault	3 fault specific environmental conditions with time stamp, counter, and if fault is currently present or intermittent
2nd occurrence	3 fault specific environmental conditions with time stamp, counter, and if fault is currently present or intermittent
3rd occurrence	3 fault specific environmental conditions with time stamp, counter, and if fault is currently present or intermittent
last occurrence	3 fault specific environmental conditions with time stamp, counter, and if fault is currently present or intermittent
Siemens Systems	DIS Tester Information
initial fault	4 fault specific environmental conditions with time stamp, counter, and if fault is currently present or intermittent

Print Change End Services Help

BMW Diagnosis DIAGNOSIS REQUESTS

115 Hot-film air mass flow
 Current type of
 Voltage Value
 The fault is not currently
 Detected 5

First fault detection 0h 24min ago
 Engine speed 600 rpm
 Coolant temperature 71 C
 Throttle-valve angle 4 degreee

Second fault detection 0h 0min ago
 Engine speed 640
 Coolant temperature 94
 Throttle valve angle 4.5

Quick test
 Note #

Function Selection Document Test Schedule System

Print Change End Services Help

BMW Diagnosis DIAGNOSIS REQUESTS

Third fault recognition before 0h 6min at:
 Engine speed 680
 Coolant temperature 94
 Throttle-valve angle 4.5 degree

Last fault detection 0h 6min ago
 Engine speed 560 rpm
 Coolant temperature 94 C
 Throttle valve angle 5.5 degree

Quick test
 Note #

Function Selection Document Test Schedule System

BMW Diagnosis FAULTS

1 Throttle valve 1 potentiometer 1,
voltage too low (OBDII code P1543)

Cause of fault in the electronics of throttle
valve 1 or associated wires and connectors:

Wiper voltage of pot. 1 in TV1 falls below
the minimum permissible value of 0.20 V

Stored as the 3th fault in the fault memory

Short circuit to earth

Open circuit

Fault constantly present

Fault occurred 1 times

US only: fault lamp (Check Engine) is not being
activated by the EMLIIIS control unit
at this moment

US only: OBDII code P1543 is at this moment
neither stored, nor can it be read out

Note
#

E38 shown

Emission Control Function Monitoring & Comprehensive Component Monitoring

OBD II regulations are based on section 1968. 1 of Title 13, California Code of Regulations (CCR), The law set forth in section 1968.1 requires an increase scope of monitoring emission related control functions including:

- Catalyst Monitoring
- Heated Catalyst Monitoring (not currently used on BMW vehicles)
- Misfire Monitoring
- Evaporative System Monitoring
- Secondary Air System Monitoring
- Air Conditioning System Refrigerant Monitoring (Not applicable for BMW vehicles)
- Fuel System Monitoring
- Oxygen Sensor Monitoring
- Exhaust Gas Recirculation (EGR) System Monitoring (Not applicable for BMW vehicles)
- Positive Crankcase Ventilation (PCV) System Monitoring (Not required at this time).
- Thermostat Monitoring (Not required at this time)

Monitoring these emission requirements is a function of the engine control module which uses “data sets” while monitoring the conditions of the environment and the operation of the engine using existing input sensors and output actuators.

The data sets are programmed reference values the engine control module refers to when a specific monitoring procedure is occurring. If the control module cannot determine the environmental and/or engine operating conditions due to an impaired or missing signal, it will set a fault and illuminate the Check Engine Light as described on page 9.

This input or control signal monitoring falls under another category called “**Comprehensive Component Monitoring**”.

The control module must recognize the loss or impairment of the signal or component. It determines a faulted signal or sensor via three conditions:

1. Signal or component shorted to ground.
2. Signal or component shorted to B+
3. Signal or component *lost* (open circuit)

Specific fault codes are used to alert the diagnostician of these conditions.

DME: MS41.1 (Siemens), M5.2 (Bosch), M5.2.1 (Bosch)
Engines: M44, M52, S52, M52ORVR, M62, M62MJ98, M73, M73MJ98

Fault Code List OBD II

M44	M52	M62	M73	FC dec hex	Fault Type and Function	OBD II Requirement / type of test	Signal Type - Signal Range - Detection of	Input /Output	Explanation	Remark
		X	X	1 01	M62M73MJ98 only: EVAP: LDP Valve - Final Stage	Final stage Check	Output digital on/off (active low)	LDP	The final stage inside the DME will set an internal flag whenever a short to ground, a short to battery voltage or a disconnection between the output transistor and the connected comp. occurs (0.02A<i>i</i><2A).	
	X			1 01	Ignition Coil Cyl. 2	Ignition Feedback	Input analog 100 mV Timing	Ignition Shunt Resistor	The DME initiates the secondary ignition for each cylinder then looks for the feedback through the shunt resistor in the harness to determine if the ignition actually occurred.	
X		X		2 02	Running losses valve - Final stage	Final stage Check	Output digital pulse width (active low)	Running losses -valve	The final stage inside the DME will set an internal flag whenever a short to ground, a short to battery voltage or a disconnection between the output transistor and the connected comp. occurs (0.02A<i>i</i><2A).	
	X			2 02	Ignition Coil Cyl. 4	Ignition Feedback	Input analog 100 mV Timing	Ignition Shunt Resistor	The DME initiates the secondary ignition for each cylinder then looks for the feedback through the shunt resistor in the harness to determine if the ignition actually occurred.	
		X	X	3 03	M62M73MJ98 only: EVAP: Reed Switch not closed, doesn't open or doesn't close	EVAP Monitoring	Input digital 12V on/off	LDP reed contact switch	Within a predetermined time the LDP reed switch signal has to change from high to low or from low to high or LDP reed switch is "low" for longer than the predetermined time.	detailed in OBD II training
	X			3 03	Ignition Coil Cyl. 6	Ignition Feedback	Input analog 100 mV Timing	Ignition Shunt Resistor	The DME initiates the secondary ignition for each cylinder then looks for the feedback through the shunt resistor in the harness to determine if the ignition actually occurred.	
		X	X	4 04	O2-Sensor-Heater, Post Cat.(Bank2), Insufficient Heating.	Final stage Check	Output digital pulse width (active low)	O2 Sensor	The final stage inside the DME will set an internal flag whenever a short to ground, a short to battery voltage or a disconnection between the output transistor and the connected comp. occurs (0.02A<i>i</i><2A).	detailed in OBD II training
	X			5 05	Injector Circuit Cylinder 2	Final stage Check	Output digital pulse width (active low)	Injector	The final stage inside the DME will set an internal flag whenever a short to ground, a short to battery voltage or a disconnection between the output transistor and the connected comp. occurs (0.02A<i>i</i><2A).	
		X	X	5 05	O2 Sensor Heater, Pre Cat.(Bank2) insufficient.	Final stage Check	Output digital pulse width (active low)	O2 Sensor	The final stage inside the DME will set an internal flag whenever a short to ground, a short to battery voltage or a disconnection between the output transistor and the connected comp. occurs (0.02A<i>i</i><2A).	detailed in OBD II training
	X			6 06	Injector Circuit Cylinder 1	Final stage Check	Output digital pulse width (active low)	Injector	The final stage inside the DME will set an internal flag whenever a short to ground, a short to battery voltage or a disconnection between the output transistor and the connected comp. occurs (0.02A<i>i</i><2A).	
		X	X	6 06	M62M73MJ98 only: CAN-Timeout Instrument Cluster	Timing Check	Input digital 0-12V binary information	Instrument Cluster	The CAN message was not received within the expected time	
		X		7 07	M62M73MJ98 only: Engine coolant temperature, radiator outlet	Signal Range Check	Input analog 12V voltage	temperature sensor on radiator outlet	Failed the Signal Range check against predefined diagnostic limits	
X		X	X	8 08	Misfire with low fuel detected	Misfire Monitoring	DME internal Values logical	Calculated	Misfire fault was recorded while the low fuel / reserve light in the instrument cluster was illuminated.	detailed in OBD II training

**DME: MS41.1 (Siemens), M5.2 (Bosch), M5.2.1 (Bosch)
Engines: M44, M52, S52, M52ORVR, M62, M62MJ98, M73, M73MJ98**

Fault Code List OBD II

M44	M52	M62	M73	FC dec hex	Fault Type and Function	OBD II Requirement / type of test	Signal Type - Signal Range - Detection of	Input /Output	Explanation	Remark
	X			8 08	Mass or Volume Air Flow Circuit, Range/Perf.	Signal Range Check	Input analog 0-5V voltage	HFM	Failed the Signal Range check against predefined diagnostic limits	
X		X		10 0A	O2 Sensor Pre Cat. (Bank1)	O2-Sensor Check	Input analog 0-1V (high is rich)	O2 Sensor	The oxygen sensor signal range is checked to determine if electrical shorts exist on the input line.	Detailed in OBD II training
	X			10 0A	Engine Coolant Temp. Circuit Range/Perf.	Signal Range Check	Input analog 0-5V voltage	Coolant Temp sensor	Signal Range is checked against the predefined diagnostic limits.	
	X			11 0B	EVAP System, Pressure Sensor, Range and Performance.	EVAP Monitoring	Input analog 0-5V voltage	Tank pressure sensor	Signal Range is checked against predefined diagnostic limits	detailed in OBD II training
	X			12 0C	O2 Sensor Post Cat.(Bank1)	O2-Sensor Check	Input analog 0-1V (high is rich)	O2 Sensor	The oxygen sensor signal range is checked to determine if electrical shorts exist on the input line.	Detailed in OBD II training
	X			12 0C	Throttle Position Sensor	Rationality Check	Input analog 0-5V voltage	Throttle position sensor	Signal Range is checked against the predetermined diagnostic limits. A fault will set if the Air Flow meter value (volume) does not logically match throttle position sensor value (throttle opening).	
	X			13 0D	O2 Sensor Heater Circuit Pre Cat (Bank1)	Final stage Check	Output digital pulse width (active low)	O2 Sensor	The final stage inside the DME will set an internal flag whenever a short to ground, a short to battery voltage or a disconnection between the output transistor and the connected comp. occurs (0.02A<i>i</i><2A).	detailed in OBD II training
	X			14 0E	O2-Sensor-Heater, Post Cat. (Bank1); insufficient.	Final stage Check	Output digital pulse width (active low)	O2 Sensor	The final stage inside the DME will set an internal flag whenever a short to ground, a short to battery voltage or a disconnection between the output transistor and the connected comp. occurs (0.02A<i>i</i><2A).	detailed in OBD II training
	X			14 0E	Intake Air Temperature Range/Performance	Signal Range Check	Input analog 0-5V voltage	Intake Temp sensor	Signal Range is checked against predefined diagnostic limits	
	X			15 0F	O2 Sensor Pre Cat. (Bank1), Slow Response time	O2-Sensor Check	Input analog 0-1V (high is rich)	O2 Sensor	Checks the amount of time the oxygen sensor stays in its rich or lean state. If it remains too long in either rich or lean condition, the fault will set.	detailed in OBD II training
	X			16 10	O2-Sensor Pre Cat (Bank 1)	O2-Sensor Check	Input analog 0-1V (high is rich)	O2 Sensor	Checks the amount of time the oxygen sensor takes to switch from rich to lean and vice versa. If it takes too long to switch the fault will set.	detailed in OBD II training
	X			16 10	AC Compressor Pulse Width Signal (E-39 only)	Timing Check	Input digital 0-12V pulse width	IHKA	Plausibility Check of pulse width modulation of the square wave signal frequency and if it's permanently high or low.	
	X			17 11	O2 Sensor Post Cat. (Bank1), Slow Response time	O2-Sensor Check	Input analog 0-1V (high is rich)	O2 Sensor	Checks the amount of time the oxygen sensor stays in its rich or lean state. If it remains too long in either the rich or the lean condition, the fault will set.	detailed in OBD II training

**DME: MS41.1 (Siemens), M5.2 (Bosch), M5.2.1 (Bosch)
Engines: M44, M52, S52, M52ORVR, M62, M62MJ98, M73, M73MJ98**

Fault Code List OBD II

M44	M52	M62	M73	FC dec hex	Fault Type and Function	OBD II Requirement/ type of test	Signal Type Signal Range Detection of	Input/Output	Explanation	Remark
X				18	EWS Signal not present or faulty	DME HW Test SIO	Input binary stream 0-12V Bit information	EWS	During the time out check no signal was present within the specific time or faulty information from serial interface (party, overrun, etc.)	
	X	X		12						
	X			18	O2 Sensor Pre Cat. (Bank2)	O2-Sensor Check	Input analog 0-1V (high is rich)	O2 Sensor	The oxygen sensor signal range is checked to determine if electrical shorts exist on the input line.	detailed in OBD II training
		X		12						
		X		19	M73LEVMY99 only: CAN Signal, Timeout EKAT	Timing Check	Input digital 0-12V binary information	ECU for electrically heated Catalyst	The CAN message was not received within the expected time	
	X			13						
	X			20	Check Engine Light, final stage Malfunction	Final stage Check	Output digital steady (active low)	Instrument Cluster	The final stage inside the DME will set an internal flag whenever a short to ground, a short to battery voltage or a disconnection between the output transistor and the connected comp. occurs (0.02A<i>i</i><2A).	
				14						
	X	X		20	O2 Sensor Post Cat. (Bank2)	O2-Sensor Check	Input analog 0-1V (high is rich)	O2 Sensor	The oxygen sensor signal range is checked to determine if electrical shorts exist on the input line.	detailed in OBD II training
				14						
	X			21	VANOS electrical fault, Malfunction	Final stage Check	Output digital on/off (active low)	VANOS valve	The final stage inside the DME will set an internal flag whenever a short to ground, a short to battery voltage or a disconnection between the output transistor and the connected comp. occurs (0.02A<i>i</i><2A).	
				15						
	X	X		21	O2 Sensor Pre Cat. (Bank2) Slow Response time	O2-Sensor Check	Input analog 0-1V (high is rich)	O2 Sensor	Checks the amount of time the oxygen sensor stays in its rich or lean state. If it remains too long in either the rich or the lean condition, the fault will set.	detailed in OBD II training
				15						
	X			22	Injector Circuit Cylinder 3, Malfunction	Final stage Check	Output digital pulse width (active low)	injector	The final stage inside the DME will set an internal flag whenever a short to ground, a short to battery voltage or a disconnection between the output transistor and the connected comp. occurs (0.02A<i>i</i><2A).	
				16						
	X	X		22	O2-Sensor Pre Cat (Bank 2)	O2-Sensor Check	Input analog 0-1V (high is rich)	O2 Sensor	Checks the amount of time the oxygen sensor takes to switch from rich to lean and vice versa. If it takes too long to switch the fault will set.	detailed in OBD II training
				16						
	X			23	Injector Circuit Cylinder 6, Malfunction	Final stage Check	Output digital pulse width (active low)	injector	The final stage inside the DME will set an internal flag whenever a short to ground, a short to battery voltage or a disconnection between the output transistor and the connected comp. occurs (0.02A<i>i</i><2A).	
				17						
	X	X		23	O2 Sensor Post Cat. (Bank2) Slow Response time	O2-Sensor Check	Input analog 0-1V (high is rich)	O2 Sensor	Checks the amount of time the oxygen sensor stays in its rich or lean state. If it remains too long in either the rich or the lean condition, the fault will set.	detailed in OBD II training
				17						
	X			24	Injector Circuit Cylinder 4, Malfunction	Final stage Check	Output digital pulse width (active low)	injector	The final stage inside the DME will set an internal flag whenever a short to ground, a short to battery voltage or a disconnection between the output transistor and the connected comp. occurs (0.02A<i>i</i><2A).	
				18						
X		X		24	AC Compressor Function	Rationality Check	Input digital 0-12V on/off	IHKKA	Fault will set if AC-Switch is off and Compressor Switch is on.	
				18						

**DME: MS41.1 (Siemens), M5.2 (Bosch), M5.2.1 (Bosch)
Engines: M44, M52, S52, M52ORVR, M62, M62MJ98, M73, M73MJ98**

Fault Code List OBD II

M44	M52	M62	M73	FC dec hex	Fault Type and Function	OBD II Requirement / type of test	Signal Type - Signal Range - Detection of	Input/Output	Explanation	Remark
X				25	O2 Sensor Heater Circuit Pre Cat (Bank1)	Final stage Check	Output digital pulse width (active low)	O2 Sensor	The final stage inside the DME will set an internal flag whenever a short to ground, a short to battery voltage or a disconnection between the output transistor and the connected comp. occurs (0.02A<i>-</i>2A).	detailed in OBD II training
X		X		19	Fuel Trim at part load (Bank1), Multiplicative	Fuel System Monitoring	DME internal Values	Calculated	Range control of adaptation values	detailed in OBD II training
X				26	Idle Control Valve Closing Coil, Malfunction	Final stage Check	Output digital pulse width, 120Hz (active low)	Idle control valve	The final stage inside the DME will set an internal flag whenever a short to ground, a short to battery voltage or a disconnection between the output transistor and the connected comp. occurs (0.02A<i>-</i>2A).	
X		X		1A		Fuel System Monitoring	DME internal Values	Calculated	Range control of adaptation values	detailed in OBD II training
X				27	Fuel Adaptation Additive at idle (Bank 1)	Fuel System Monitoring	logical	Calculated	Range control of adaptation values	detailed in OBD II training
X		X		1B		Fuel System Monitoring	DME internal Values	Calculated	Range control of adaptation values	detailed in OBD II training
X		X		28	Fuel Trim (Bank1), Additive	Fuel System Monitoring	logical	Calculated	Range control of adaptation values	detailed in OBD II training
X				1C		Final stage Check	Output digital on/off (active low)	air containment valve	The final stage inside the DME will set an internal flag whenever a short to ground, a short to battery voltage or a disconnection between the output transistor and the connected comp. occurs (0.02A<i>-</i>2A).	
X		X		29	M62/M73MY98 only: air containment valve for air control of shrouded fuel injector (Bank 1)	Final stage Check	Input analog 100 mV Timing	Ignition Shunt Resistor	The DME initiates the secondary ignition for each cylinder then looks for the feedback through the shunt resistor in the harness to determine if the ignition actually occurred.	
X				1D		Ignition Feedback	Input analog 100 mV Timing	Ignition Shunt Resistor	not applied yet - future enhancement for MY99	
		X		30	M73LEVMY99 only: EKAT-Status 7 - power switch control	Electrically heated catalyst check	Input digital 0-12V binary information	EKAT-ECU		
				1E		Ignition Feedback	Input analog 100 mV Timing	Ignition Shunt Resistor	The DME initiates the secondary ignition for each cylinder then looks for the feedback through the shunt resistor in the harness to determine if the ignition actually occurred.	
X				30	Ignition Coil Cyl. 3	Ignition Feedback	Input analog 100 mV Timing	Ignition Shunt Resistor	The DME initiates the secondary ignition for each cylinder then looks for the feedback through the shunt resistor in the harness to determine if the ignition actually occurred.	
X				1E		Ignition Feedback	DME internal Values	Idle control Valve	Plausibility check between the actual engine speed and the predetermined engine speed. Fault will set if not within the desired RPM range (+200/-100 rpm)	
X		X		31	Idle Control Valve stuck mechanically	Plausibility Check	logical	Idle control Valve	not applied yet - future enhancement for MY99	
				1F		Electrically heated catalyst check	Input digital 0-12V binary information	EKAT-ECU		
X		X		32	M73LEVMY99 only: EKAT-Status 8 - EKAT-ECU	Final stage Check	Output digital pulse width (active low)	Injector	The final stage inside the DME will set an internal flag whenever a short to ground, a short to battery voltage or a disconnection between the output transistor and the connected comp. occurs (0.02A<i>-</i>2A).	
				20		Final stage Check				
				33	Injector Circuit Cylinder 5, Malfunction	Final stage Check				
				21						
				21						

**DME: MS41.1 (Siemens), M5.2 (Bosch), M5.2.1 (Bosch)
Engines: M44, M52, S52, M52ORVR, M62, M62MJ98, M73, M73MJ98**

Fault Code List OBD II

M44	M52	M62	M73	FC dec hex	Fault Type and Function	OBD II Requirement / type of test	Signal Type Signal Range Detection of	Input/Output	Explanation	Remark
		X	X	34	Fuel Trim (Bank2), Multiplicative	Fuel System Monitoring	DME internal Values logical	Calculated	Range control of adaptation values	detailed in OBD II training
	X			22	Secondary Air Injection System , el. Pump	Final stage Check	Output digital on/off (active low)	Air pump	The final stage inside the DME will set an internal flag whenever a short to ground, a short to battery voltage or a disconnection between the output transistor and the connected comp. Occurs (0.02A<I<2A).	
X		X		35	Fuel Adaptation Additive at idle (Bank 2)	Fuel System Monitoring	DME internal Values logical	Calculated	Range control of adaptation values	detailed in OBD II training
	X	X		23	Fuel Trim at part load (Bank2), Additive	Fuel System Monitoring	DME internal Values logical	Calculated	Range control of adaptation values	detailed in OBD II training
	X			36	EWS Content of Message	Manipulation Check	Input binary stream 0-12V Bit information	EWS	The content of the binary message received from EWS was invalid	
X		X		24	Catalyst Efficiency Bank 1, Below Threshold	Catalyst Monitoring	Input analog 0-1V voltage	O2 Sensor pre/post catalyst	Compares the value of the pre cat O2 sensor to value of the post cat O2 sensor to measure the oxygen storage capability / efficiency of the catalytic converter. The post O2 sensor must be relatively lean.	detailed in OBD II training
		X	X	39	M73LEVMY99 only: EKAT-Status 1 - Disconnection of heater for Catalyst 1	Electrically heated catalyst check	input digital 0-12V binary information	EKAT-ECU	not applied yet - future enhancement for MY99	
		X	X	27	M73LEVMY99 only: EKAT-Status 2 - switch on operating condition catalyst 1	Electrically heated catalyst check	input digital 0-12V binary information	EKAT-ECU	not applied yet - future enhancement for MY99	
		X	X	40	M73LEVMY99 only: EKAT-Status 3 - power switch Catalyst 1	Electrically heated catalyst check	input digital 0-12V binary information	EKAT-ECU	not applied yet - future enhancement for MY99	
		X	X	28	Catalyst Efficiency Bank 2, Below Threshold	Catalyst Monitoring	Input analog 0-1V voltage	O2 Sensor pre/post catalyst	Compares the value of the pre cat O2 sensor to value of the post cat O2 sensor to measure the oxygen storage capability / efficiency of the catalytic converter. The post O2 sensor must be relatively lean.	detailed in OBD II training
		X	X	42	M73LEVMY99 only: EKAT-Status 4 - Disconnection heater for Catalyst 2	Electrically heated catalyst check	input digital 0-12V binary information	EKAT-ECU	not applied yet - future enhancement for MY99	
		X	X	2A	M73LEVMY99 only: EKAT-Status 5 - switch on operating condition catalyst 2	Electrically heated catalyst check	input digital 0-12V binary information	EKAT-ECU	not applied yet - future enhancement for MY99	
		X	X	43	M73LEVMY99 only: EKAT-Status 6 - power switch catalyst.2	Electrically heated catalyst check	input digital 0-12V binary information	EKAT-ECU	not applied yet - future enhancement for MY99	
		X	X	2B						
		X	X	44						
		X	X	2C						
		X	X	45						
		X	X	2D						
		X	X	46						
		X	X	2E						
		X	X	47						
		X	X	2F						
		X	X	48						
		X	X	30						

**DME: MS41.1 (Siemens), M5.2 (Bosch), M5.2.1 (Bosch)
Engines: M44, M52, M52, S52, M52ORVR, M62, M62MJ98, M73, M73MJ98**

Fault Code List OBD II

M44	M52	M62	M73	FC dec hex	Fault Type and Function	OBD II Requirement / type of test	Signal Type - Signal Range - Detection of	Input /Output	Explanation	Remark
	X			50	Running Loss Valve (3/2), final stage	Final stage Check	Output digital on/off (active low)	RL valve	The final stage inside the DME will set an internal flag whenever a short to ground, a short to battery voltage or a disconnection between the output transistor and the connected comp. occurs (0.02A<i>i</i><2A).	
X		X	X	32	Cylinder 1 Misfire detected	Misfire Monitoring	DME internal Values (active low)	Calculated	Crankshaft speed/acceleration is monitored by the crank sensor. The time for each cylinders combustion is compared against the average of the others. If the time for cylinder 1 is longer the fault will set.	detailed in OBD II training
	X			51	Shut Off Valve, Malfunction	Final stage Check	Output digital steady (active low)	Shut off valve	The final stage inside the DME will set an internal flag whenever a short to ground, a short to battery voltage or a disconnection between the output transistor and the connected comp. Occurs (0.02A<i>i</i><2A).	
X		X	X	33	Cylinder 2 Misfire detected	Misfire Monitoring	DME internal Values (active low)	Calculated	Crankshaft speed/acceleration is monitored by the crank sensor. The time for each cylinders combustion is compared against the average of the others. If the time for cylinder 2 is longer the fault will set.	detailed in OBD II training
	X			52	Rear Exhaust Valve flap	Final stage Check	Output digital steady (active low)	Valve for exhaust flap	The final stage inside the DME will set an internal flag whenever a short to ground, a short to battery voltage or a disconnection between the output transistor and the connected comp. occurs (0.02A<i>i</i><2A).	
X		X	X	34	Cylinder 3 Misfire detected	Misfire Monitoring	DME internal Values (active low)	Calculated	Crankshaft speed/acceleration is monitored by the crank sensor. The time for each cylinders combustion is compared against the average of the others. If the time for cylinder 3 is longer the fault will set.	Detailed in OBD II training
	X			53	Idle Control Valve Opening Coil, Malfunction	Final stage Check	Output digital pulse width, 120Hz (active low)	Idle control valve	The final stage inside the DME will set an internal flag whenever a short to ground, a short to battery voltage or a disconnection between the output transistor and the connected comp. occurs (0.02A<i>i</i><2A).	
X		X	X	35	Cylinder 4 Misfire detected	Misfire Monitoring	DME internal Values (active low)	Calculated	Crankshaft speed/acceleration is monitored by the crank sensor. The time for each cylinders combustion is compared against the average of the others. If the time for cylinder 4 is longer the fault will set.	detailed in OBD II training
	X			54	Cylinder 5 Misfire detected	Misfire Monitoring	DME internal Values (active low)	Calculated	Crankshaft speed/acceleration is monitored by the crank sensor. The time for each cylinders combustion is compared against the average of the others. If the time for cylinder 5 is longer the fault will set.	detailed in OBD II training
	X			55	O2 Sensor Heater Circuit Pre Cat (Bank2)	Final stage Check	Output digital pulse width (active low)	O2 Sensor	The final stage inside the DME will set an internal flag whenever a short to ground, a short to battery voltage or a disconnection between the output transistor and the connected comp. occurs (0.02A<i>i</i><2A).	detailed in OBD II training
	X			56	Cylinder 6 Misfire detected	Misfire Monitoring	DME internal Values (active low)	Calculated	Crankshaft speed/acceleration is monitored by the crank sensor. The time for each cylinders combustion is compared against the average of the others. If the time for cylinder 6 is longer the fault will set.	detailed in OBD II training
	X			57	Ignition Feedback, interruption at shunt resistor	Ignition Feedback	Input analog 32V Voltage	Ignition Shunt Resistor	Check for correct signal voltage If Voltage is 32V (Zener Voltage) than secondary ignition voltage is detected then there might be a problem with the shunt resistor in the harness.	
	X			58	Cylinder 7 Misfire detected	Misfire Monitoring	DME internal Values (active low)	Calculated	Crankshaft speed/acceleration is monitored by the crank sensor. The time for each cylinders combustion is compared against the average of the others. If the time for cylinder 7 is longer the fault will set.	detailed in OBD II training

DME: MS41.1 (Siemens), M5.2 (Bosch), M5.2.1 (Bosch)
Engines: M44, M52, S52, M52ORVR, M62, M62MJ98, M73, M73MJ98

Fault Code List OBD II

M44	M52	M62	M73	FC dec hex	Fault Type and Function	OBD II Requirement / type of test	Signal Type - Signal Range - Detection of	Input /Output	Explanation	Remark
	X			57	Knock Sensor 1 Circuit, (Bank 1)	Circuit continuity Signal Range Check	Input analog 13-19kHz amplitude	Knock sensor	Plausibility Check between the knock sensor amplitude during knocking with the internal knock detection mapped DME values.	
		X		39	Cylinder 8 Misfire detected	Misfire Monitoring	DME internal Values logical	Calculated	Crankshaft speed/acceleration is monitored by the crank sensor. The time for each cylinders combustion is compared against the average of the others. If the time for cylinder 8 is longer the fault will set.	detailed in OBD II training
	X			59	Knock Sensor 2 Circuit, (Bank 2)	Circuit continuity Signal Range Check	Input analog 13-19kHz amplitude	Knock sensor	Plausibility Check between the knock sensor amplitude during knocking with the internal knock detection mapped DME values.	
	X			3B	O2 Sensor Heater Circuit Post Cat. (Bank2)	Final stage Check	Output digital pulse width (active low)	O2 Sensor	The final stage inside the DME will set an internal flag whenever a short to ground, a short to battery voltage or a disconnection between the output transistor and the connected comp. occurs (0.02A<I<2A).	detailed in OBD II training
	X			61	Secondary Air Inj. System Switching Valve	Final stage Check	Output digital on/off (active low)	Air valve	The final stage inside the DME will set an internal flag whenever a short to ground, a short to battery voltage or a disconnection between the output transistor and the connected comp. Occurs (0.02A<I<2A).	
		X		62	Random/Multiple Cylinder, Misfire detected	Misfire Monitoring	DME internal Values logical	Calculated	Crankshaft speed/acceleration is monitored by the crank sensor. The time for each cylinders combustion is compared against the average of the others. If the time for a cylinder is longer the fault will set.	detailed in OBD II training
X		X		3E	Cylinder 1 Misfire detected, catalyst damaging	Misfire Monitoring	DME internal Values logical	Calculated	Crankshaft speed/acceleration is monitored by the crank sensor. The time for each cylinders combustion is compared against the average of the others. If the time for cylinder 1 is longer the fault will set.	detailed in OBD II training
X		X		63	Cylinder 2 Misfire detected, catalyst damaging	Misfire Monitoring	DME internal Values logical	Calculated	Crankshaft speed/acceleration is monitored by the crank sensor. The time for each cylinders combustion is compared against the average of the others. If the time for cylinder 2 is longer the fault will set.	detailed in OBD II training
X		X		3F	Cylinder 3 Misfire detected, catalyst damaging	Misfire Monitoring	DME internal Values logical	Calculated	Crankshaft speed/acceleration is monitored by the crank sensor. The time for each cylinders combustion is compared against the average of the others. If the time for cylinder 3 is longer the fault will set.	detailed in OBD II training
X		X		64	Camshaft Position Sensor Circuit, Malfunction	Rationality Check	Input analog 0-5V phase shift	CAM sensor	Internal check of the phase shift from the cam sensor which should change during every crankshaft revolution. The phase shift occurs due to the 2:1 mechanical relationship between cam and crank.	
	X			41	Cylinder 4 Misfire detected, catalyst damaging	Misfire Monitoring	DME internal Values logical	Calculated	Crankshaft speed/acceleration is monitored by the crank sensor. The time for each cylinders combustion is compared against the average of the others. If the time for cylinder 4 is longer the fault will set.	detailed in OBD II training
		X		66	Cylinder 5 Misfire detected, catalyst damaging	Misfire Monitoring	DME internal Values logical	Calculated	Crankshaft speed/acceleration is monitored by the crank sensor. The time for each cylinders combustion is compared against the average of the others. If the time for cylinder 5 is longer the fault will set.	detailed in OBD II training
		X		42	EVAP System, Purge Control Valve Circuit	Final stage Check	Output digital steady (active low)	purge valve	The final stage inside the DME will set an internal flag whenever a short to ground, a short to battery voltage or a disconnection between the output transistor and the connected comp. occurs (0.02A<I<2A).	detailed in OBD II training
	X			67						
		X		43						
	X			68						
				44						

**DME: MS41.1 (Siemens), M5.2 (Bosch), M5.2.1 (Bosch)
Engines: M44, M52, S52, M52ORVR, M62, M62MJ98, M73, M73MJ98**

Fault Code List OBD II

M44	M52	M62	M73	FC dec hex	Fault Type and Function	OBD II Requirement / type of test	Signal Type - Signal Range - Detection of	Input/Output	Explanation	Remark
		X	X	68 44	Cylinder 6 Misfire detected, catalyst damaging	Misfire Monitoring	DME internal Values logical	Calculated	Crankshaft speed/acceleration is monitored by the crank sensor. The time for each cylinders combustion is compared against the average of the others. If the time for cylinder 6 is longer the fault will set.	detailed in OBD II training
	X			69 45	Relay Fuel Pump	Final stage Check	Output digital on/off (active low)	Relay fuel pump	The final stage inside the DME will set an internal flag whenever a short to ground, a short to battery voltage or a disconnection between the output transistor and the connected comp. occurs (0.02A<i><2A</i>).	
		X	X	69 45	Cylinder 7 Misfire detected, catalyst damaging	Misfire Monitoring	DME internal Values logical	Calculated	Crankshaft speed/acceleration is monitored by the crank sensor. The time for each cylinders combustion is compared against the average of the others. If the time for cylinder 7 is longer the fault will set.	detailed in OBD II training
		X	X	70 46	Cylinder 8 Misfire detected, catalyst damaging	Misfire Monitoring	DME internal Values logical	Calculated	Crankshaft speed/acceleration is monitored by the crank sensor. The time for each cylinders combustion is compared against the average of the others. If the time for cylinder 8 is longer the fault will set.	detailed in OBD II training
			X	71 47	Cylinder 9 Misfire detected, catalyst damaging	Misfire Monitoring	DME internal Values logical	Calculated	Crankshaft speed/acceleration is monitored by the crank sensor. The time for each cylinders combustion is compared against the average of the others. If the time for cylinder 9 is longer the fault will set.	detailed in OBD II training
		X	X	72 48	Cylinder 10 Misfire detected, catalyst damaging	Misfire Monitoring	DME internal Values logical	Calculated	Crankshaft speed/acceleration is monitored by the crank sensor. The time for each cylinders combustion is compared against the average of the others. If the time for cylinder 10 is longer the fault will set.	detailed in OBD II training
		X	X	73 49	Cylinder 11 Misfire detected, catalyst damaging	Misfire Monitoring	DME internal Values logical	Calculated	Crankshaft speed/acceleration is monitored by the crank sensor. The time for each cylinders combustion is compared against the average of the others. If the time for cylinder 11 is longer the fault will set.	detailed in OBD II training
	X			74 4A	Relay AC Compressor	Final stage Check	Output digital on/off (active low)	Relay AC Compr.	The final stage inside the DME will set an internal flag whenever a short to ground, a short to battery voltage or a disconnection between the output transistor and the connected comp. occurs (0.02A<i><2A</i>).	
		X	X	74 4A	Cylinder 12 Misfire detected, catalyst damaging	Misfire Monitoring	DME internal Values logical	Calculated	Crankshaft speed/acceleration is monitored by the crank sensor. The time for each cylinders combustion is compared against the average of the others. If the time for cylinder 12 is longer the fault will set.	detailed in OBD II training
X		X	X	75 4B	Random/Multiple Cylinder, Misfire detected	Misfire Monitoring	DME internal Values logical	Calculated	Crankshaft speed/acceleration is monitored by the crank sensor. The time for each cylinders combustion is compared against the average of the others. If the time for a cylinder is longer the fault will set.	detailed in OBD II training
	X			75 4B	O2 Sensor Pre Cat. (Bank1)	O2-Sensor Check	Input analog 0-5V (high is lean)	O2 Sensor	The oxygen sensor signal range is checked to determine if electrical shorts exist on the input line. The voltage signal has to be within a predetermined range (0.1V - 4.9V) or a fault will set.	detailed in OBD II training
	X			76 4C	O2 Sensor Pre Cat. (Bank2)	O2-Sensor Check	Input analog 0-5V (high is lean)	O2 Sensor	The oxygen sensor signal range is checked to determine if electrical shorts exist on the input line. The voltage signal has to be within a predetermined range (0.1V - 4.9V) or a fault will set.	detailed in OBD II training
		X	X	77 4D	M62/M73MY98 only: air containment valve for air control of shrouded fuel injector (Bank 2)	Final stage Check	Output digital on/off (active low)	air containment valve	The final stage inside the DME will set an internal flag whenever a short to ground, a short to battery voltage or a disconnection between the output transistor and the connected comp. occurs (0.02A<i><2A</i>).	

**DME: MS41.1 (Siemens), M5.2 (Bosch), M5.2.1 (Bosch)
Engines: M44, M52, M52, S52, M52ORVR, M62, M62MJ98, M73, M73MJ98**

Fault Code List OBD II

M44	M52	M62	M73	FC dec hex	Fault Type and Function	OBD II Requirement / type of test	Signal Type - Signal Range - Detection of	Input /Output	Explanation	Remark
X				77 4D	O2 Sensor Post Cat. (Bank1)	O2-Sensor Check	Input analog 0-5V (high is lean)	O2 Sensor	The oxygen sensor signal range is checked to determine if electrical shorts exist on the input line. The voltage signal has to be within a predetermined range (0.1V - 4.9V) or a fault will set.	detailed in OBD II training
X				78 4E	O2 Sensor Post Cat. (Bank2)	O2-Sensor Check	Input analog 0-5V (high is lean)	O2 Sensor	The voltage signal has to be within a predetermined range (0.1V - 4.9V) or a fault will set.	detailed in OBD II training
X	X	X		78 4E	Crankshaft Position Sensor (too many teeth)	Rationality Check	Input digital 0-12V frequency/pattern	Crank sensor	Crank sensor signal reports that too many teeth were detected within one crankshaft revolution. The fault will set if more teeth was detected than the default value.	
X	X			79 4F	O2 Sensor Heater Circuit (Bank1, Sensor2)	Final stage Check	Output digital pulse width (active low)	O2 Sensor	The final stage inside the DME will set an internal flag whenever a short to ground, a short to battery voltage or a disconnection between the output transistor and the connected comp. occurs (0.02A<i>-</i>2A).	detailed in OBD II training
X		X		80 50	Secondary Air Control	Secondary Air Delivery	Input analog 0-1V voltage	O2 Sensor	Checks to see if the O2 sensor reacts to the increase in unmetered air flow generated by the secondary air pump operation. The O2 sensor must sense the lean condition or a fault will set.	
X				80 50	ASC Signal, active too long	Timing Check	Input digital 0-12V timing	ASC	Time out Check, Fault occurs when ASC signal is active for more than 5 seconds	
		X		81 51	M73LEVMY99 only: EKAT-Status 9 - sensor check temperature sensor (1) in battery	Electrically heated catalyst check	Input digital 0-12V binary information	EKAT-ECU	not applied yet - future enhancement for MY99	
X				81 51	MSR Signal, active too long	Timing Check	Input digital 0-12V timing	ASC	Time out Check, Fault when MSR signal is active for more than 5 seconds	
		X		82 52	M73LEVMY99 only: EKAT-Status 10 - sensor check temperature sensor (2) in battery	Electrical heated catalyst check	Input digital 0-12V binary information	EKAT-ECU	not applied yet - future enhancement for MY99	
X				82 52	EML Signal, active too long	Timing Check	Input digital 0-12V timing	ASC	Time out Check, Fault when EML signal is active for more than 5 seconds	
		X		83 53	M73LEVMY99 only: EKAT-Status 11 - plausibility check of temperature sensor in battery.	Electrical heated catalyst check	Input digital 0-12V binary information	EKAT-ECU	not applied yet - future enhancement for MY99	
X				83 53	Crankshaft Position Sensor, Malfunction	Rationality Check	Input digital 0-12V frequency/pattern	Crank sensor	Checks for correct signal pattern and correct number of expected flywheel teeth.	
X		X		84 54	Secondary Air Pump Final stage	Final stage Check	Output digital on/off (active low)	Secondary Air pump	The final stage inside the DME will set an internal flag whenever a short to ground, a short to battery voltage or a disconnection between the output transistor and the connected comp. occurs (0.02A<i>-</i>2A).	

**DME: MS41.1 (Siemens), M5.2 (Bosch), M5.2.1 (Bosch)
Engines: M44, M52, S52, M52ORVR, M62, M62MJ98, M73, M73MJ98**

Fault Code List OBD II

M44	M52	M62	M73	FC dec hex	Fault Type and Function	OBD II Requirement / type of test	Signal Type - Signal Range - Detection of	Input /Output	Explanation	Remark
X		X		84 54	M44/M73MJ98 only: CDTSLPE: secondary air pump - final stage	Final stage Check	Output digital on/off (active low)	secondary air pump	The final stage inside the DME will set an internal flag whenever a short to ground, a short to battery voltage or a disconnection between the output transistor and the connected comp. occurs (0.02A<i>-</i>2A).	
X		X		85 55	Secondary Air Valve Final stage	Final stage Check	Output digital on/off (active low)	Secondary Air valve	The final stage inside the DME will set an internal flag whenever a short to ground, a short to battery voltage or a disconnection between the output transistor and the connected comp. occurs (0.02A<i>-</i>2A).	
	X			91 5B	M62/M73MJ98 only: EVAP System, Purge Control Valve Circuit (Bank 2)	Final stage Check	Output digital on/off (active low)	purge valve	The final stage inside the DME will set an internal flag whenever a short to ground, a short to battery voltage or a disconnection between the output transistor and the connected comp. occurs (0.02A<i>-</i>2A).	
X		X		93 5D	EVAP Emission Control System	EVAP Monitoring	Input analog 0-5V voltage	Tank pressure sensor	The final stage inside the DME will set an internal flag whenever a short to ground, a short to battery voltage or a disconnection between the output transistor and the connected comp. occurs (0.02A<i>-</i>2A).	detailed in OBD II training
X				94 5E	EVAP System Large Leak	EVAP Monitoring	Input analog 0-5V voltage	Tank pressure sensor	During purging with the open TEV valve the tank pressure sensor must react to the decrease in pressure. It must reach a minimum pressure differential after a predetermined time or a fault will set.	detailed in OBD II training
X				96 60	Shut Off Valve, Malfunction	Final stage Check	Output digital steady (active low)	Shut off valve	The final stage inside the DME will set an internal flag whenever a short to ground, a short to battery voltage or a disconnection between the output transistor and the connected comp. Occurs (0.02A<i>-</i>2A).	
X				97 61	EVAP System Small Leak detected	EVAP Monitoring	Input analog 0-5V voltage	Tank pressure sensor	With the purge open and shut off valve closed the gas tank is introduced to intake manifold vacuum. The tank pressure sensor looks for a predetermined pressure (vacuum) difference within a specific time.	detailed in OBD II training
X		X		98 62	EVAP System, Purge Control Valve Circuit	Final stage Check	Output digital on/off (active low)	purge valve	The final stage inside the DME will set an internal flag whenever a short to ground, a short to battery voltage or a disconnection between the output transistor and the connected comp. occurs (0.02A<i>-</i>2A).	
	X			100 64	Internal Control Module, Memory check sum or internal communication	DME HW Test Memory	DME internal Values logical	DME internally	Internal hardware test of RAM, ROM, and Flash Prom.	
		X		100 64	M73LEV only: Transmission/ coolant heat exchanger	Final stage Check	Output digital on/off (active low)	Trans/coolant heat exchanger	The final stage inside the DME will set an internal flag whenever a short to ground, a short to battery voltage or a disconnection between the output transistor and the connected comp. occurs (0.02A<i>-</i>2A).	
X		X		101 65	Internal Control Module, RAM	DME HW Test Memory	DME internal Values logical	DME internally	Internal hardware test of RAM, ROM, and Flash Prom.	
X		X		102 66	Internal Control Module, Keep Alive Memory	DME HW Test Memory	DME internal Values logical	DME internally	Internal hardware test of RAM, ROM, and Flash Prom.	
X		X		103 67	Internal Control Module, Memory check sum	DME HW Test Memory	DME internal Values logical	DME internally	Internal hardware test of RAM, ROM, and Flash Prom.	

**DME: MS41.1 (Siemens), M5.2 (Bosch), M5.2.1 (Bosch)
Engines: M44, M52, S52, M52ORVR, M62, M62MJ98, M73, M73MJ98**

Fault Code List OBD II

M44	M52	M62	M73	FC dec hex	Fault Type and Function	OBD II Requirement / type of test	Signal Type - Signal Range - Detection of	Input/Output	Explanation	Remark
X		X	X	104 68	Internal Control Module, RAM	DME HW Test Memory	DME internal Values logical	DME internally	Internal hardware test of RAM, ROM, and Flash Prom.	
		X	X	105 69	M62/M73MY98 only: Internal Control Module, EEPROM	DME HW Test Memory	DME internal Values logical	DME internally	Internal hardware test of RAM, ROM, and Flash Prom.	
X		X	X	107 6B	Battery Voltage	Signal Range Check	Input analog Batt. Voltage voltage	Battery Voltage	Check that proper battery voltage is present between 9 and 16 Volts. This check is not performed during cranking due to voltage drop.	
X		X	X	108 6C	Battery Voltage Disconnected	Rationality Check	Input analog Batt. Voltage voltage continuity	Battery Voltage	ECU internal test determines if the unit has been disconnected from battery power. This fault could be set by disconnection of the battery or control unit or wiring problem effecting B+ supply or ground.	
X		X	X	111 6F	Crankshaft Position Sensor, Malfunction	Rationality Check	Input digital 0-12V frequency/pattern	Crank sensor	Checks for correct signal pattern and correct number of expected flywheel teeth.	
X		X	X	112 70	Camshaft Position Sensor Circuit, Malfunction	Rationality Check	Input analog 0-5V phase shift	Cam sensor	Internal check of the phase shift from the cam sensor which should change during every crankshaft revolution. The phase shift occurs due to the 2:1 mechanical relationship between cam and crank.	
X		X	X	115 73	Mass or Volume Air Flow Circuit, Malfunction	Signal Range Check	Input analog 0-5V voltage	HFM	Failed the Signal Range check against predefined diagnostic limits	
X		X	X	117 75	Throttle Position Sensor	Rationality Check	Input analog 0-5V voltage	Throttle position sensor	Signal Range is checked against the predetermined diagnostic limits. A fault will set if the Air Flow meter value (volume) does not logically match throttle position sensor value (throttle opening).	
X		X	X	120 78	Vehicle Speed Sensor	Rationality Check	Input digital 0-12V binary combination	ASC	Signal Range is checked against predefined diagnostic limits. No vehicle speed is observed after a specific time when compared to engine speed and load which is equivalent to a moving vehicle.	
X		X	X	121 79	Load Calculation Cross Check, Range/Perf.	Signal Range Check Rationality Check	Input analog 0-5V voltage	HFM, Throttle pos sensor	Plausibility check between the Throttle Position Sensor Signal and the HFM.	
X		X	X	123 7B	Engine Coolant Temp. Circuit Range/Perf.	Signal Range Check	Input analog 0-5V voltage	Coolant Temp sensor	Signal Range is checked against the predefined diagnostic limits and the calculated temperature.	
X		X	X	124 7C	Intake Air Temperature Range/Performance	Signal Range Check	Input analog 0-5V voltage	Intake Temp. sensor	Signal Range is checked against predefined diagnostic limits	
X		X	X	130 82	Swapped O2 Sensors Pre Cat.	O2 Sensor Check	DME internal Value logical	O2 Sensor	Fault will set if the O2 sensor from one bank shows a rich condition while the other bank shows a lean condition.	detailed in OBD II training

DME: MS41.1 (Siemens), M5.2 (Bosch), M5.2.1 (Bosch)
Engines: M44, M52, S52, M52ORVR, M62, M62MJ98, M73, M73MJ98

Fault Code List OBD II

M44	M52	M62	M73	FC dec hex	Fault Type and Function	OBD II Requirement / type of test	Signal Type - Signal Range - Detection of	Input /Output	Explanation	Remark
			X	133 85	M73MY98 only: DME Bank identification input	Rationality Check	Input digital on/off	Bank identification- pin wiring harness check	DME identifies itself as a DME_Right or DME_Left depending how the input signal is wired. If it determines that the "learned" value has changed then a fault is detected.	
X		X	X	135 87	Transmission: Torque Reduction	Rationality Check	Input digital 0-12V binary information	EGS	CAN message had an invalid or undefined value	
		X	X	138 8A	AC Compressor Torque Reduction	Timing Check	Input digital 0-12V binary information	IHKa via K-Bus from the Instr. Cluster	Checks CAN message for proper content of pulse width modulation signal (>MY97)	
		X	X	139 8B	Electric Thermostat Control, final stage	Final stage Check	Output digital on/off (active low)	Electric Thermostat	The final stage inside the DME will set an internal flag whenever a short to ground, a short to battery voltage or a disconnection between the output transistor and the connected comp. occurs (0.02A<l<2A).	
		X	X	140 8C	M73MY98 only: Torque imbalance	Rationality Check	Input analog 0-5V voltage	HFM1 and HFM2	Comparison between the 2 air mass signals. If the difference is too large then a fault is detected. Most likely cause is and air leak.	
		X	X	141 8D	ASC Signal, Plausibility check	Rationality Check	Input digital 0-12V binary combination	ASC	Internal check of binary signals from ASC/MSR/EML. The control unit knows what are the possible combinations of signals. If the combined signals don't match the internal table the fault will be set.	
X		X	X	143 8F	MSR Signal	Timing Check	Input digital 0-12V binary combination	ASC	Internal check of binary signals from ASC/MSR/EML. The control unit knows what are the possible combinations of signals. If the combined signals don't match the internal table the fault will be set.	
X		X	X	144 90	ASC Signal, Plausibility Torque Reduction	Timing Check	Input digital 0-12V binary combination	ASC	Internal check of binary signals from ASC/MSR/EML. The control unit knows what are the possible combinations of signals. If the combined signals don't match the internal table the fault will be set.	
		X	X	147 93	Electric Thermostat Control, Range/Performance.	Final stage Check	Output digital on/off (active low)	Electric Thermostat	The final stage inside the DME will set an internal flag whenever a short to ground, a short to battery voltage or a disconnection between the output transistor and the connected comp. occurs (0.02A<l<2A).	
X		X	X	148 94	EWS Signal not present or faulty	DME HW Test SIO	Input binary stream 0-12V Bit information	EWS	During the time out check no signal was present within the specific time or faulty information from serial interface (parity, overrun, etc.)	
X		X	X	150 96	Injector Circuit Cylinder 1, Malfunction	Final stage Check	Output digital pulse width (active low)	Injector	The final stage inside the DME will set an internal flag whenever a short to ground, a short to battery voltage or a disconnection between the output transistor and the connected comp. occurs (0.02A<l<2A).	
X		X	X	151 97	Injector Circuit Cylinder 2, Malfunction	Final stage Check	Output digital pulse width (active low)	Injector	The final stage inside the DME will set an internal flag whenever a short to ground, a short to battery voltage or a disconnection between the output transistor and the connected comp. occurs (0.02A<l<2A).	
X		X	X	152 98	Injector Circuit Cylinder 3, Malfunction	Final stage Check	Output digital pulse width (active low)	Injector	The final stage inside the DME will set an internal flag whenever a short to ground, a short to battery voltage or a disconnection between the output transistor and the connected comp. occurs (0.02A<l<2A).	

DME: MS41.1 (Siemens), M5.2 (Bosch), M5.2.1 (Bosch)
Engines: M44, M52, S52, M52ORVR, M62, M62MJ98, M73, M73MJ98

Fault Code List OBD II

M44	M52	M62	M73	FC dec hex	Fault Type and Function	OBD II Requirement / type of test	Signal Type - Signal Range - Detection of	Input /Output	Explanation	Remark
X		X	X	153 99	Injector Circuit Cylinder 4, Malfunction	Final stage Check	Output digital pulse width (active low)	Injector	The final stage inside the DME will set an internal flag whenever a short to ground, a short to battery voltage or a disconnection between the output transistor and the connected comp. occurs (0.02A<i>-</i>2A).	
		X	X	154 9A	Injector Circuit Cylinder 5, Malfunction	Final stage Check	Output digital pulse width (active low)	Injector	The final stage inside the DME will set an internal flag whenever a short to ground, a short to battery voltage or a disconnection between the output transistor and the connected comp. occurs (0.02A<i>-</i>2A).	
		X	X	155 9B	Injector Circuit Cylinder 6, Malfunction	Final stage Check	Output digital pulse width (active low)	Injector	The final stage inside the DME will set an internal flag whenever a short to ground, a short to battery voltage or a disconnection between the output transistor and the connected comp. occurs (0.02A<i>-</i>2A).	
		X	X	156 9C	Injector Circuit Cylinder 7, Malfunction	Final stage Check	Output digital pulse width (active low)	Injector	The final stage inside the DME will set an internal flag whenever a short to ground, a short to battery voltage or a disconnection between the output transistor and the connected comp. occurs (0.02A<i>-</i>2A).	
		X	X	157 9D	Injector Circuit Cylinder 8, Malfunction	Final stage Check	Output digital pulse width (active low)	Injector	The final stage inside the DME will set an internal flag whenever a short to ground, a short to battery voltage or a disconnection between the output transistor and the connected comp. occurs (0.02A<i>-</i>2A).	
		X	X	158 9E	Injector Circuit Cylinder 9, Malfunction	Final stage Check	Output digital pulse width (active low)	Injector	The final stage inside the DME will set an internal flag whenever a short to ground, a short to battery voltage or a disconnection between the output transistor and the connected comp. occurs (0.02A<i>-</i>2A).	
		X	X	159 9F	Injector Circuit Cylinder 10, Malfunction	Final stage Check	Output digital pulse width (active low)	Injector	The final stage inside the DME will set an internal flag whenever a short to ground, a short to battery voltage or a disconnection between the output transistor and the connected comp. occurs (0.02A<i>-</i>2A).	
		X	X	160 A0	Injector Circuit Cylinder 11, Malfunction	Final stage Check	Output digital pulse width (active low)	Injector	The final stage inside the DME will set an internal flag whenever a short to ground, a short to battery voltage or a disconnection between the output transistor and the connected comp. occurs (0.02A<i>-</i>2A).	
		X	X	161 A1	Injector Circuit Cylinder 12, Malfunction	Final stage Check	Output digital pulse width (active low)	Injector	The final stage inside the DME will set an internal flag whenever a short to ground, a short to battery voltage or a disconnection between the output transistor and the connected comp. occurs (0.02A<i>-</i>2A).	
		X	X	163 A3	M73MJ98 only: Electric Fuel Pump Relay, Final stage (Bank 2)	Final stage Check	Output digital on/off (active low)	Fuel pump relay	The final stage inside the DME will set an internal flag whenever a short to ground, a short to battery voltage or a disconnection between the output transistor and the connected comp. occurs (0.02A<i>-</i>2A).	
		X	X	164 A4	M62/M73MJ98 only: EVAP: Barometric Tank Pressure Sensor	Signal Range Check	Input analog 0-5V voltage	Tank pressure sensor	The Signal Range is checked to detect shorts on the input line	
X		X	X	165 A5	Check Engine Light, Final stage Malfunction	Final stage Check	Output digital on/off (active low)	Instrument Cluster	The final stage inside the DME will set an internal flag whenever a short to ground, a short to battery voltage or a disconnection between the output transistor and the connected comp. occurs (0.02A<i>-</i>2A).	
X		X	X	167 A7	Electric Fuel Pump Relay, Final stage	Final stage Check	Output digital on/off (active low)	Fuel pump relay	The final stage inside the DME will set an internal flag whenever a short to ground, a short to battery voltage or a disconnection between the output transistor and the connected comp. occurs (0.02A<i>-</i>2A).	

DME: MS41.1 (Siemens), M5.2 (Bosch), M5.2.1 (Bosch)
Engines: M44, M52, M52, S52, M52ORVR, M62, M62MJ98, M73, M73MJ98

Fault Code List OBD II

M44	M52	M62	M73	FC dec hex	Fault Type and Function	OBD II Requirement / type of test	Signal Type - Signal Range - Detection of	Input /Output	Explanation	Remark
X		X		168 A8	Idle Control Valve Opening Coil, Malfunction	Final stage Check	Output digital pulse width (active low)	Idle control valve	The final stage inside the DME will set an internal flag whenever a short to ground, a short to battery voltage or a disconnection between the output transistor and the connected comp. occurs (0.02A<-2A).	
X		X		169 A9	Idle Control Valve Closing Coil, Malfunction	Final stage Check	Output digital pulse width (active low)	Idle control valve	The final stage inside the DME will set an internal flag whenever a short to ground, a short to battery voltage or a disconnection between the output transistor and the connected comp. occurs (0.02A<-2A).	
X		X		170 AA	AC Compressor Control	Final stage Check	Output digital on/off (active low)	AC Comp.	The final stage inside the DME will set an internal flag whenever a short to ground, a short to battery voltage or a disconnection between the output transistor and the connected comp. Occurs (0.02A<-2A).	
X		X		175 AF	DISA, Range/Performance	Final stage Check	Output digital on/off (active low)	Disa Valve	The final stage inside the DME will set an internal flag whenever a short to ground, a short to battery voltage or a disconnection between the output transistor and the connected comp. occurs (0.02A<-2A).	
		X		179 B3	M73MY98 only: AC Compressor Control (Bank 2)	Final stage Check	Output digital on/off (active low)	AC-Control	The final stage inside the DME will set an internal flag whenever a short to ground, a short to battery voltage or a disconnection between the output transistor and the connected comp. occurs (0.02A<-2A).	
		X		183 B7	M62M73MY98 only: EVAP: Large Leak detected	EVAP Monitoring	Input digital 12V Frequency	LDP reed contact	The frequency of the LDP pumps reed switch is above the predetermined "small" leak range. The larger the leak the higher the frequency will be.	detailed in OBD II training
		X		184 B8	M62M73MY98 only: EVAP: pinched hose check	EVAP Monitoring	Input digital 12V Frequency	LDP reed contact	The frequency of the LDP pumps reed switch is lower than the predetermined limit. The volume of leak is determined to be too small as in a pinched or restricted hose.	detailed in OBD II training
	X			190 BE	Only E39MY98: EVAP: Reed Switch not closed	EVAP Monitoring	Input digital 12V Frequency	LDP reed contact	The fault will set if the signal from LDP reed switch is "low" for longer than the predetermined time.	detailed in OBD II training
	X			191 BF	Only E39MY98: EVAP: Reed Switch doesn't open	EVAP Monitoring	Input digital 12V on/off	LDP reed contact	Within a predetermined time the LDP reed switch signal has to change from high to low or a fault will set.	detailed in OBD II training
	X			192 C0	Only E39MY98: EVAP: Reed Switch doesn't close	EVAP Monitoring	Input digital 12V on/off	LDP reed contact	Within a predetermined time the LDP reed switch signal has to change from high to low or a fault will set.	detailed in OBD II training
	X			193 C1	Only E39MY98: EVAP: Clamped Tube Check	EVAP Monitoring	Input digital 12V Frequency	LDP reed contact	The frequency of the LDP pumps reed switch is lower than the predetermined limit. The volume of leak is determined to be too small as in a pinched or restricted hose.	detailed in OBD II training
	X			194 C2	Only E39MY98: EVAP: Large Leak detected	EVAP Monitoring	Input digital 12V Frequency	LDP reed contact	The frequency of the LDP pumps reed switch is above the predetermined "small" leak range. The larger the leak the higher the frequency will be.	detailed in OBD II training
	X			195 C3	Only E39MY98: EVAP: Small Leak detected	EVAP Monitoring	Input digital 12V Frequency	LDP reed contact	The frequency of the LDP pumps reed switch is above the predetermined "small" leak range. The larger the leak the higher the frequency will be.	detailed in OBD II training

**DME: MS41.1 (Siemens), M5.2 (Bosch), M5.2.1 (Bosch)
Engines: M44, M52, S52, M52ORVR, M62, M62MJ98, M73, M73MJ98**

Fault Code List OBD II

M44	M52	M62	M73	FC dec hex	Fault Type and Function	OBD II Requirement/ type of test	Signal Type - Signal Range - Detection of	Input/Output	Explanation	Remark
X				196 C4	Only E39MY98: EVAP: el. Valve LDP	Final stage Check	Output digital on/off (active low)	LDP	The final stage inside the DME will set an internal flag whenever a short to ground, a short to battery voltage or a disconnection between the output transistor and the connected comp. occurs (0.02A<-2A).	
X				197 C5	Only E39MY98: EVAP: Barometric Pressure Sensor	Signal Range Check	Input analog 0-5V voltage	Tank pressure sensor	The Signal Range is checked to detect shorts on the input line	
X				200 C8	O2 Sensor Pre Cat. (Bank1), No Activity	O2-Sensor Check	Input analog 0-5V (high is lean)	O2 Sensor	The oxygen sensor signal has to be oscillating under certain normal engine operation conditions. The O2 amplitude signal check must have a minimum of height.	detailed in OBD II training
X				201 C9	O2 Sensor Pre Cat. (Bank2) No Activity	O2-Sensor Check	Input analog 0-5V (high is lean)	O2 Sensor	The oxygen sensor signal has to be oscillating under certain normal engine operation conditions. The O2 amplitude signal check must have a minimum of height.	detailed in OBD II training
X				202 CA	Fuel Trim (Bank1), O2 Control Limit	Fuel System Monitoring	DME internal Values	Calculated	The Controller for Lambda is too long beyond a min. or a max. limit	detailed in OBD II training
X				203 CB	Fuel Trim (Bank2), O2 Control Limit	Fuel System Monitoring	DME internal Values	Calculated	The Controller for Lambda is too long beyond a min. or a max. limit	detailed in OBD II training
	X	X		203 CB	M62/M73MY98 only: Ignition Feedback (bank failed)	Ignition Feedback	Input analog 100 mV Timing	Ignition Shunt Resistor	Check for correct signal timing after each ignition has been initiated by this feedback signal	
	X	X		204 CC	M62/M73MY98 only: rolling code storage	DME HW-Test	DME internal Values	EWS	The EWS3.3 rolling code is not stored properly in the DME internal memory	
X				204 CC	Idle Control System, Idle Speed not plausible	Rationality Check	DME internal Values	calculated	Functional Check between the actual engine speed (RPM) and the predetermined RPM exceeds the maximum deviation of +200/-100 RPM.	
	X			208 D0	Secondary Air Induction System (Bank 2)	Secondary Air Delivery	Input analog 0-1V voltage	O2 Sensor	Checks to see if the O2 sensor reacts to the increase in unmetered air flow generated by the secondary air pump operation. The O2 sensor must sense the lean condition or a fault will set.	
X				209 D1	EWS Content of Message	Manipulation Check	Input binary stream 0-12V Bit information	EWS	The content of the binary message received from EWS was invalid	
X		X		210 D2	Knock Sensor 1 Circuit, (Bank 1)	Circuit continuity Signal Range Check	Input analog 13-19kHz amplitude	Knock sensor	Plausibility Check between the knock sensor amplitude during knocking with the internal knock detection mapped DME values.	
	X			210 D2	Ignition Feedback, faulty (>2 Cylinders)	Ignition Feedback	Input analog 100 mV Timing	Ignition Shunt Resistor	Check for correct signal timing after each ignition has been initiated by this feedback signal. If more than two ignitions is not recognized than there might be a problem in the feedback line itself	

**DME: MS41.1 (Siemens), M5.2 (Bosch), M5.2.1 (Bosch)
Engines: M44, M52, S52, M52ORVR, M62, M62MJ98, M73, M73MJ98**

Fault Code List OBD II

M44	M52	M62	M73	FC dec hex	Fault Type and Function	OBD II Requirement/ type of test	Signal Type - Signal Range - Detection of	Input/Output	Explanation	Remark
X		X	X	211 D3	Knock Sensor 2 Circuit, (Bank 2)	Circuit continuity Signal Range Check	Input analog 13-19kHz amplitude	Knock sensor	Plausibility Check between the knock sensor amplitude during knocking with the internal knock detection mapped DME values.	
	X			211 D3	Idle Control Valve stuck mechanically	Rationality Check	DME internal Values logical	calculated	Functional Check against a calculated value by monitoring the flow through the air mass meter to determine if the idle valve is mechanically stuck open. Tested during closed throttle deceleration.	
		X	X	212 D4	Knock Sensor Signal 3	Circuit continuity Signal Range Check	Input analog 13-19kHz amplitude	Knock sensor	Plausibility Check between the knock sensor amplitude during knocking with the internal knock detection mapped DME values.	
	X			212 D4	VANOS mechanically stuck (Bank1)	Rationality Check	DME internal Values logical	Crank/ cam sensor	Plausibility check between crank and cam sensor signals (timing) before and after the Vanos is switched active.	
		X	X	213 D5	Knock Sensor Signal 4	Circuit continuity Signal Range Check	Input analog 13-19kHz amplitude	Knock sensor	Plausibility Check between the knock sensor amplitude during knocking with the internal knock detection mapped DME values.	
		X	X	214 D6	M62/M73MY98 only: CAN-Index Verification	CAN Message Check	Input digital 0-12V binary information	Any ECU on CAN	Logical check of every ECU on the CAN bus has a CAN message interpretation (refer to CAN-Index on the DIS-Tester page) that applies to the vehicle	
	X			214 D6	Vehicle Speed Sensor	Rationality Check	Input digital 0-12V frequency	ASC	Signal Range is checked against predefined diagnostic limits. No vehicle speed is observed after a specific time when compared to engine speed and load which is equivalent to a moving vehicle.	
	X			215 D7	ASC/MSR/EML-Interface not plausible	Rationality Check	Input digital 0-12V binary combination	ASC	Internal check of binary signals from ASC/MSR/EML. The control unit knows what are the possible combinations of signals. If the combined signals don't match the internal table the fault will be set.	
		X	X	215 D7	M62/M73MY98 only: CAN-Signal, Timeout Left / Right DME	Timing Check	Input digital 0-12V binary information	both DMEs	The Left DME will check for the Right DME and vice versa. If the CAN message was not received by either within the expected time a fault will set.	
	X			216 D8	Gear Selector Signal, Signal Undefined	Rationality Check	Input digital 0-12V binary information	EGS	CAN message had an invalid or undefined value	
		X	X	216 D8	CAN Signal, Timeout ASC	Timing Check	Input digital 0-12V binary information	ASC	The CAN message was not received within the expected time	
	X			217 D9	CAN Time Out (EGS1)	DME HW Test CAN	Input digital 0-12V binary information	EGS	CAN message between DME/EGS was not received within the expected time	
			X	217 D9	M62/M73MY98 only: CAN-Signal, Timeout EML	Timing Check	Input digital 0-12V binary information	EML ECU	The CAN message was not received within the expected time	

**DME: MS41.1 (Siemens), M5.2 (Bosch), M5.2.1 (Bosch)
Engines: M44, M52, S52, M52ORVR, M62, M62MJ98, M73, M73MJ98**

Fault Code List OBD II

M44	M52	M62	M73	FC dec hex	Fault Type and Function	OBD II Requirement/ type of test	Signal Type - Signal Range - Detection of	Input /Output	Explanation	Remark
X				219 DB	CAN-Chip, Bus Off	DME HW Test CAN	input digital 0-12V binary information	Any ECU on CAN	Hardware test determines if Can Bus is off line. Data transmission is disturbed.	
X		X	X	220 DC	Knock control, Test pulse	Circuit continuity Signal Range Check	DME internal Values logical	DME internally	The ECU internally generated pulse was not detected. It is used to verify electrical integrity (shorts or disconnection) of the knock control circuitry both internally and externally.	
X		X	X	222 DE	Knock control, Test pulse (Bank2)	Circuit continuity Signal Range Check	DME internal Values logical	DME internally	The ECU internally generated pulse was not detected. It is used to verify electrical integrity (shorts or disconnection) of the knock control circuitry both internally and externally.	
X				222 DE	Insufficient Coolant Temp. to permit Closed Loop Operation.	Rationality Check	Input analog 0-5V voltage	Coolant Temp sensor	Comparison of actual coolant temperature against the calculated DME value which varies with the load signal.	
		X	X	225 E1	M73LEVMY99 only: EKAT-Status 12 - temperature sensor - plausibility power switch	Electrically heated catalyst check	Input digital 0-12V binary information	EKAT-ECU	not applied yet - future enhancement for M799	
		X	X	226 E2	M73LEVMY99 only: EKAT-Status 13 - - temperature sensor - plausibility power switch	Electrically heated catalyst check	Input digital 0-12V binary information	EKAT-ECU	not applied yet - future enhancement for M799	
		X	X	227 E3	M73LEVMY99 only: EKAT-Status 14 - plausibility check of battery disconnection switch	Electrically heated catalyst check	Input digital 0-12V binary information	EKAT-ECU	not applied yet - future enhancement for M799	
X				227 E3	Fuel Trim (Bank1), O2 Control Adaptation Limit	Fuel System Monitoring	DME internal Values logical	Calculated	Range control of adaptation values	detailed in OBD II training
		X	X	228 E4	M62/M73MJ98 only: Automatic Start, Output (Bank 2)	Final stage Check	Output digital on/off (active low)	Starter Relay	The final stage inside the DME will set an internal flag whenever a short to ground, a short to battery voltage or a disconnection between the output transistor and the connected comp. occurs (0.02A<i>k</i>2A).	
X				228 E4	Fuel Trim (Bank2), O2 Control Adaptation Limit	Fuel System Monitoring	DME internal Values logical	Calculated	Range control of adaptation values	detailed in OBD II training
X				229 E5	O2 Sensor Pre Cat. (Bank1) Slow Response time	O2-Sensor Check	Input analog 0-5V (high is lean)	O2 Sensor	Checks the amount of time the oxygen sensor stays in its rich or lean state. If it remains there too long in either the fault will set.	detailed in OBD II training
X				230 E6	O2 Sensor Pre Cat. (Bank2) Slow Response time	O2-Sensor Check	Input analog 0-5V (high is lean)	O2 Sensor	Checks the amount of time the oxygen sensor stays in its rich or lean state. If it remains there too long in either the fault will set.	detailed in OBD II training
X				231 E7	O2-Sensor Pre Cat (Bank 1), Switching time too slow	O2-Sensor Check	Input analog 0-5V (high is lean)	O2 Sensor	Checks the amount of time the oxygen sensor takes to switch from rich to lean and vice versa. If it takes too long to switch the fault will set.	detailed in OBD II training

**DME: MS41.1 (Siemens), M5.2 (Bosch), M5.2.1 (Bosch)
Engines: M44, M52, M52, S52, M52ORVR, M62, M62MJ98, M73, M73MJ98**

Fault Code List OBD II

M44	M52	M62	M73	FC dec hex	Fault Type and Function	OBD II Requirement / type of test	Signal Type - Signal Range - Detection of	Input / Output	Explanation	Remark
	X			232 E8	O2-Sensor Pre Cat (Bank 2), Switching time too slow	O2-Sensor Check	Input analog 0-5V (high is lean)	O2 Sensor	Checks the amount of time the oxygen sensor takes to switch from rich to lean and vice versa. If it takes too long to switch the fault will set.	detailed in OBD II training
	X			233 E9	Catalyst Efficiency Bank 1, Below Threshold	Catalyst Monitoring	Input analog 0-5V voltage	O2 Sensor pre/post catalyst	Compares the value of the pre cat O2 sensor to value of the post cat O2 sensor to measure the oxygen storage capability / efficiency of the catalytic converter. The post O2 sensor must be relatively lean.	detailed in OBD II training
		X		233 E9	M62/M73MJ98 only: Automatic Start, Output	Final stage Check	Output digital on/off (active low)	Starter Relay	The final stage inside the DME will set an internal flag whenever a short to ground, a short to battery voltage or a disconnection between the output transistor and the connected comp. occurs (0.02A<i>-</i>2A).	
	X			234 EA	Catalyst Efficiency Bank 2, Below Threshold	Catalyst Monitoring	Input analog 0-5V voltage	O2 Sensor pre/post catalyst	Compares the value of the pre cat O2 sensor to value of the post cat O2 sensor to measure the oxygen storage capability / efficiency of the catalytic converter. The post O2 sensor must be relatively lean.	detailed in OBD II training
		X		234 EA	Automatic Start, Input	Rationality Check	Input digital 0-12V on/off	KL50	Fault will set if after a predetermined time with engine revolution is greater than a limit and KL50 still active	
	X			235 EB	O2-Sensor-Heater, Post Cat. (Bank1), Insufficient Heating.	O2-Sensor Check	Internal Shunt Current	O2 Sensor	Checks the amount of time it takes to heat the O2 sensor to a predetermined limit as measured by the change in the lean signal. This test occurs during deceleration only.	detailed in OBD II training
X		X		236 EC	CAN Time Out (EGS)	DME HW Test CAN	Input digital 0-12V binary information	EGS	CAN message between DME/EGS was not received within the expected time	
	X			236 EC	O2-Sensor-Heater, Post Cat. (Bank2), Insufficient Heating.	O2-Sensor Check	Output digital on/off current	O2 Sensor	Checks the amount of time it takes to heat the O2 sensor to a predetermined limit as measured by the change in the lean/rich signal. This test occurs during deceleration only.	detailed in OBD II training
		X		237 ED	Automatic Start, Output	Final stage Check	Output digital on/off (active low)	Starter Relay	The final stage inside the DME will set an internal flag whenever a short to ground, a short to battery voltage or a disconnection between the output transistor and the connected comp. occurs (0.02A<i>-</i>2A).	
	X			238 EE	Cylinder 1 Misfire detected	Misfire Monitoring	DME internal Values logical	Calculated	Crankshaft speed/acceleration is monitored by the crank sensor. The time for each cylinders combustion is compared against the average of the others. If the time for cylinder 1 is longer the fault will set.	detailed in OBD II training
	X			239 EF	Cylinder 2 Misfire detected	Misfire Monitoring	DME internal Values logical	Calculated	Crankshaft speed/acceleration is monitored by the crank sensor. The time for each cylinders combustion is compared against the average of the others. If the time for cylinder 2 is longer the fault will set.	detailed in OBD II training
	X			240 F0	Cylinder 3 Misfire detected	Misfire Monitoring	DME internal Values logical	Calculated	Crankshaft speed/acceleration is monitored by the crank sensor. The time for each cylinders combustion is compared against the average of the others. If the time for cylinder 3 is longer the fault will set.	detailed in OBD II training
	X			241 F1	Cylinder 4 Misfire detected	Misfire Monitoring	DME internal Values logical	Calculated	Crankshaft speed/acceleration is monitored by the crank sensor. The time for each cylinders combustion is compared against the average of the others. If the time for cylinder 4 is longer the fault will set.	detailed in OBD II training

DME: MS41.1 (Siemens), M5.2 (Bosch), M5.2.1 (Bosch)
Engines: M44, M52, S52, M52ORVR, M62, M62MJ98, M73, M73MJ98

Fault Code List OBD II

M44	M52	M62	M73	FC dec hex	Fault Type and Function	OBD II Requirement / type of test	Signal Type - Signal Range - Detection of	Input /Output	Explanation	Remark
X				242 F2	Cylinder 5 Misfire detected	Misfire Monitoring	DME internal Values logical	Calculated	Crankshaft speed/acceleration is monitored by the crank sensor. The time for each cylinders combustion is compared against the average of the others. If the time for cylinder 5 is longer the fault will set.	detailed in OBD II training
X				243 F3	Cylinder 6 Misfire detected	Misfire Monitoring	DME internal Values logical	Calculated	Crankshaft speed/acceleration is monitored by the crank sensor. The time for each cylinders combustion is compared against the average of the others. If the time for cylinder 6 is longer the fault will set.	detailed in OBD II training
X				244 F4	Segment Timing faulty- Flywheel adaptation	Rationality Check	Input digital 0-12V timing	Crank sensor	The flywheel segments are monitored during deceleration to establish a baseline for misfire calculation. If the segments are too long/short (bad flywheel) and exceed the limit a fault will set or one tooth too much/less.	detailed in OBD II training
X				245 F5	Secondary Air Injection (Bank1), Flow too Low	Secondary Air Delivery	Input analog 0-5V voltage	O2-Sensor signal	Checks to see if the O2 sensor reacts to the increase in unmetered airflow generated by the secondary air pump operation. The O2 sensor must sense the lean condition or a fault will set.	
X				246 F6	Secondary Air Injection (Bank2), Flow too Low	Secondary Air Delivery	Input analog 0-5V voltage	O2-Sensor signal	Checks to see if the O2 sensor reacts to the increase in unmetered airflow generated by the secondary air pump operation. The O2 sensor must sense the lean condition or a fault will set.	
X				250 FA	EVAP System, TEV	EVAP Monitoring	Input analog 0-5V voltage	O2 Sensor Signal	This functional check looks for the reaction of the O2 sensor signal during canister purging. The O2 sensor, Air Flow meter and RPM values must react to the purging of the canister	detailed in OBD II training
X				251 FB	EVAP System, Leak Detected (small leak)	EVAP Monitoring	Input analog 0-5V voltage	Tank pressure sensor	With the purge and shut off valves closed the gas tank is introduced to intake manifold vacuum. The tank pressure sensor looks for a predetermined pressure (vacuum) difference within a specific time.	detailed in OBD II training
X				252 FC	EVAP System, Incorrect Purge Flow	EVAP Monitoring	Input analog 0-5V voltage	Tank pressure sensor	During purging with the open TEV valve the tank pressure sensor must react to the decrease in pressure. It must reach a minimum pressure differential after a predetermined time or a fault will set	detailed in OBD II training
X				253 FD	EVAP System, Shut Off Valve Stuck closed	EVAP Monitoring	Input analog 0-5V voltage	Tank pressure sensor	The signal from the Tank pressure sensor determines that the tank has a pressure lower (higher vacuum) than the predetermined value. This fault will occur if the Shut off Valve is stuck closed or restricted.	detailed in OBD II training
X		X	X	253 FD	Coolant Fan, Final stage	Final stage Check	Output digital pulse width (active low)	Coolant Fan	The final stage inside the DME will set an internal flag whenever a short to ground, a short to battery voltage or a disconnection between the output transistor and the connected comp. occurs (0.02A<i>i</i>-2A).	
X				254 FE	EVAP System, Leak Detected (large leak)	EVAP Monitoring	Input analog 0-5V voltage	Tank pressure sensor	During purging with the open TEV valve the tank pressure sensor must react to the decrease in pressure. It must reach a minimum pressure differential after a predetermined time or a fault will set	detailed in OBD II training
X				255 FF	EVAP System, TEV Stuck Open	EVAP Monitoring	Input analog 0-5V voltage	purge valve	Check for HC in canister with vehicle speed equal to zero, purge and shut off valves closed the tank pressure after a predetermined time must be greater than the pressure observed during engine start	detailed in OBD II training

A

Alternate or Equivalent Phase-in: Phase in of equivalent emission reductions by the end of the last year of the scheduled phase-in.

The emission reductions are calculated by multiplying the percent of vehicles (based on the manufacturer's projected sales volume of all vehicles and engines) meeting the new requirements per year by the number of years implemented prior to and including the last year of the scheduled phase-in and then summing these yearly results to determine a cumulative total.

B

Base Fuel Schedule: refers to the fuel calibration schedule programmed into the Powertrain Control Module or PROM when manufactured or when updated by some off-board source, prior to any learned on-board correction.

C

Catalyst Monitoring:

Non-Low Emission Vehicles: The catalyst system shall be considered malfunctioning when its conversion capability decreases to the point that HC emissions increase by more than 1.5 times the standard over an FTP test from a test run with a representative 4000 mile catalyst system.

Transitional Low Emission Vehicles TLEV: these vehicles shall employ an emission threshold malfunction criterion of 2.0 times the applicable FTP HC standard plus the emissions from a test run with a representative 4000 mile catalyst system.

Low Emission Vehicles LEV: The catalyst system shall be considered malfunctioning when its conversion capability decreases to the point that either of the following occurs:

1. Hydrocarbon (HC) emissions exceed the applicable emission threshold specified. The emission threshold criterion for LEV and ULEV applications shall be 2.5 and 3.0 times the applicable FTP HC standard, respectively, plus the emission level with a representative 4000 mile catalyst system. Notwithstanding, beginning with the 1998 model year, manufacturers shall phase in an emission threshold of 1.75 times the applicable FTP HC standard for all categories of low emission vehicles, which shall not include the emission level with a 4000 mile catalyst system.

2. The average Federal Test Procedure (FTP) Non-Methane Hydrocarbon (NMHC) conversion efficiency of the monitored portion of the catalyst system falls below 50 percent.

C

CARB- California Air Resources Board: The California Air Resources Board mission is to promote and protect public health, welfare and ecological resources through the effective and efficient reduction of air pollutants while recognizing and considering the effects on the economy of the state of California.

California's Legislature established the Air Resources Board (ARB) in 1967 to:

1. Attain and maintain healthy air quality.
2. Conduct research into the causes of and solutions to air pollution.
3. Systematically attack the serious problem caused by motor vehicles, which are the major causes of air pollution in the state.

Since its formation, the ARB has worked with the public, the business sector, and local governments to protect the public's health, the economy, and the state's ecological resources through the most cost-effective reduction of air pollution.

What the ARB Does: Programs for cleaner air range from research and regulation to enforcement and education. The ARB:

1. Sets and enforces emission standards for motor vehicles , fuels, and consumer products
2. Sets health-based air quality standards
3. Conducts research
4. Monitors air quality
5. Identifies and sets control measures for toxic air contaminants
6. Provides compliance assistance for businesses
7. Produces education and outreach programs and materials
8. Oversees and assists local air quality districts which regulate most non-vehicular sources of air pollution.

For extensive information on the CARB, visit their website at = <http://www.arb.ca.gov>

Continuous monitoring: means sampling at a rate no less than two samples per second. If for engine control purposes, a computer input component is sampled less frequently, the value of the component may instead be evaluated each time sampling occurs.

“CLV” Calculated load value: A formula that refers to an indication of the current airflow divided by peak airflow, where peak airflow is corrected for altitude, if available. This definition provides a unitless number that is not engine specific, and provides the service technician with an indication of the percent engine capacity that is being used (with wide open throttle as 100%).

$$\text{CLV} = \frac{\text{Current Airflow}}{\text{Atm Pressure (@ sea level)}} \times \text{X}$$

D

Diagnostic Link Connector (DLC): SAE standardized aftermarket scantool-vehicle interface connector. Located in the interior of the vehicle.

Drive or Driving Cycle: consists of engine startup, vehicle operation and engine shutoff.

Diagnostic Trouble Code (DTC): SAE standardized OBD-II fault code. This code structure is designed by the SAE to identify identical faults along all vehicle manufacture systems. These fault codes are accessed by using an aftermarket scantool via the DLC. If using the BMW DIS or MoDiC, these fault codes provide no additional information already provided by the BMW diagnostic equipment.

E

Engine misfire: means lack of combustion in the cylinder due to absence of spark, poor fuel metering, poor compression, or any other cause.

Engine Start: is defined as the point at which normal, synchronized spark and fuel control is obtained or when the engine reaches a speed 150 rpm below the normal, warmed-up idle speed (as determined in the drive position for vehicles equipped with an automatic transmission).

Evaporative System Monitoring:

The system is considered to be malfunctioning when:

- No purge air flow can be detected (Oxygen Sensor Feedback), or
- When a leak is detected in the system that is equal to or larger than 1mm (0.040 in.).

F

Federal Test Procedure (FTP): a specific driving cycle that is utilized by the EPA to test light duty vehicles and light duty truck emissions. As part of the procedure for a vehicle manufacturer to obtain emission certification for a particular model/engine family the manufacturer must demonstrate that the vehicle(s) can pass the FTP defined driving cycle two consecutive times while monitoring various components/systems.

Some of the components/systems must be monitored either once per driving cycle or continuously.

Components/systems required to be monitored once within one driving cycle:

- Oxygen Sensors
- Secondary Air Injection System
- Catalyst Efficiency
- Evaporative Vapor Recovery System

Components/systems required to be monitored continuously:

- Misfire detection
- Fuel system
- Oxygen Sensors
- All emissions related systems providing or receiving signals to the DME, EGS, or EML.

NOTE: Due to the complexity involved in meeting the test criteria within the FTP defined driving cycle, all tests may not be completed within one "customer driving cycle". The test can be successfully completed within the FTP defined criteria, however customer driving styles may differ and therefore may not always monitor all involved components/systems in one "trip".

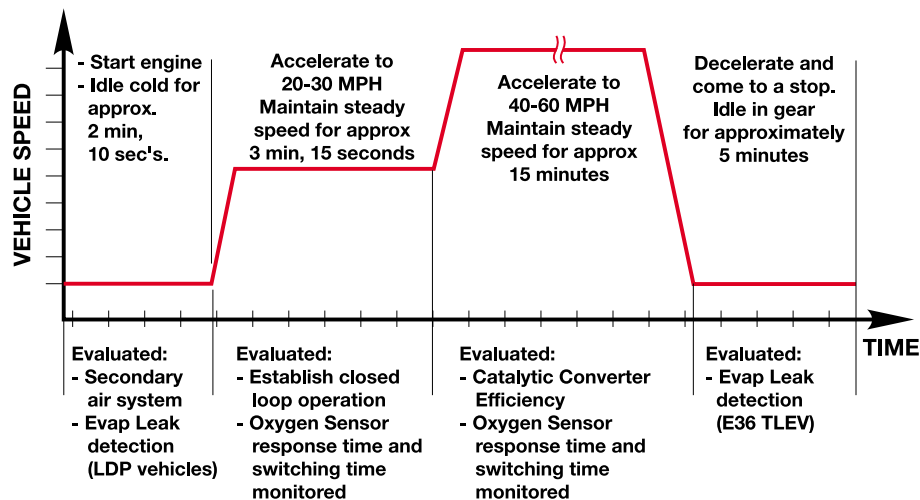

Fuel trim: refers to feedback adjustments to the base fuel schedule. Short-term fuel trim refers to dynamic or instantaneous adjustments. Long-term fuel trim refers to much more gradual adjustments to the fuel calibration schedule than short-term trim adjustments. These long term adjustments compensate for vehicle differences and gradual changes that occur over time.

Functional check: for an output component means verification of proper response to a computer command. For an input component, functional check means verification of the input signal being in the range of normal operation, including evaluation of the signals

G

H

I

J

J-Specifications: The SAE established the required specifications for the EPA/ARB OBD II program. These are known as the J specs. By visiting the SAE website @ www.sae.org, detailed information regarding the following specs can be accessed.

SAE J1930 - Standardization of system terms, definitions abbreviations and acronyms.

SAE J1962 - Diagnostic Link Connector pin assignments and manufacturing dimensions.

SAE J2012 - Definitions of Diagnostic Trouble Codes (DTCs)

There are additional J specifications related to the On Board Diagnostics Program which can be obtained by purchasing the SAE [On Board Diagnostics for Light and Medium Duty Vehicles Standards Manual](#) via the SAE website.

K

L

Low Emission Vehicle: refers to a vehicle certified in California as a Transitional Low Emission Vehicle (TLEV), a Low Emission Vehicle (LEV), or an Ultra Low Emission Vehicle (ULEV). These vehicle categories are further defined in Title 13, sections 1956.8 and 1960.1.

M

Malfunction: means the inability of an emission-related component or system to remain within design specifications.

Further, malfunction refers to the deterioration of any emission related components or system to a degree that would likely cause the emissions of an average certification durability vehicle with the deteriorated components or systems present at the beginning of the applicable certification emission test to exceed by more than 1.5 times any of the emission standards.

Misfire: means lack of combustion in the cylinder due to absence of spark, poor fuel metering, poor compression, ***or any other cause.***

Misfire Monitoring: The diagnostic system shall monitor engine misfire and shall identify the specific cylinder experiencing misfire via MIL activation and fault code. If more than one cylinder is misfiring, a separate code shall indicate that multiple cylinders are misfiring plus specifying the individual misfiring cylinders.

N

O

On-Board Diagnostics: On-Board Diagnostic (OBD) systems are incorporated into the emission related control modules (DME, EGS/AGS/EML) in new vehicles to monitor components and systems that affect emissions when malfunctioning.

California's second generation of OBD requirements (known as OBD II) have been fully in effect since the 1996 model year. OBD II systems monitor virtually every component that can affect the emission performance of the vehicle. If a problem is detected, the OBD II system illuminates a warning lamp on the vehicle instrument panel to alert the driver. This warning lamp typically contains the phrase Check Engine or Service Engine Soon. The system will also store important information about the detected malfunction so that a repair technician can accurately find and fix the problem.

Oxygen sensor "response rate": refers to the delay (measured in milliseconds) between a switch of the sensor from lean to rich or vice versa in response to a change in fuel/air ratio above and below stoichiometric.

P

P-Codes: See Diagnostic Trouble Codes

Q-R

Redline engine speed: means the manufacturer recommended maximum engine speed as normally displayed on instrument panel tachometers, or the engine speed at which fuel shutoff occurs.

S

Secondary air: refers to air introduced into the exhaust system by means of a pump or aspirator valve or other means that is intended to aid in the oxidation of HC and CO contained in the exhaust gas stream.

Small volume manufacturer: any vehicle manufacturer with sales less than or equal to 3000 new light-duty vehicles and medium-duty vehicles per model year based on the average number of vehicles sold by the manufacturer each model year from 1989 to 1991, except as follows;

For manufacturers certifying for the first time in California, model year sales shall be based on projected California sales. If a manufacturer's average California sales exceeds 3000 units of new light-duty and medium-duty vehicles based on the average number of vehicles sold for any three consecutive model years, the manufacturer shall no longer be treated as a small volume manufacturer and shall comply with the requirements applicable for larger manufacturers beginning with the fourth model year after the last of the three consecutive model years.

If a manufacturer's average California sales falls below 3000 units of new light-duty and medium-duty vehicles based on the average number of vehicles sold for any three consecutive model years, the manufacturer shall be treated as a small volume manufacturer and shall be subject to the requirements for small volume manufacturers beginning with the next model year.

T

Trip: means vehicle operation (following an engine-off period) long enough that all components and systems are monitored at least once by the diagnostic system. Catalyst efficiency and/or evaporative system monitoring does not necessarily have to occur when a steady-speed check is used. This is subject to the limitation that the manufacturer-defined trip monitoring conditions shall all be encountered at least once during the first engine start portion of the applicable FTP cycle.

U-V

Unified Cycle: is defined in "Speed Versus Time Data for California's Unified Driving Cycle", dated December 12, 1996, incorporated by reference.

W-X

Warm-up cycle: means sufficient vehicle operation such that the coolant temperature has risen by at least 40 degrees Fahrenheit from engine starting and reaches a minimum temperature of at least 160 degrees Fahrenheit (140 degrees Fahrenheit for diesel applications).

Y-Z
